

Honeywell

TC300 Commercial Thermostat

CONNECTED DEVICE FOR COMMERCIAL BUILDINGS

CONFIGURATION AND USER GUIDE



Table of contents

Important Safety Information and Installation Precautions.....	8
Introduction.....	11
About TC300 Thermostat	12
Features.....	12
Equipment control features	12
Intended audience and assumed knowledge.....	13
Reference documents.....	13
Abbreviation and nomenclature.....	13
Conventions.....	14
Dimensions	15
Technical specifications.....	16
Terminal Identification	21
Terminal assignment.....	23
Security requirement.....	24
Overview.....	25
Home screen: Temperature reading and adjustment.....	26
Quick access screen (right side screen): Device configuration.....	27
Ambiance screen (left side screen): Sensor reading	28
Home screen icon overview.....	28
Inactive display modes.....	30
Display timeout properties	31
Getting Started.....	33
Prerequisites.....	34
Boot-up the thermostat	35
Configuration.....	43

Configuration screen.....	44
Basic configuration	45
Equipment configuration	49
I/O terminal assignment.....	57
Configuring sensors.....	59
Managing System switch.....	64
Managing Discharge air control	65
Managing Dehumidification	67
Managing Valve cycle.....	68
Advanced configuration	69
Managing Setpoint options	70
Managing Cooling options.....	72
Managing Heating options	74
Managing Pipe sensor thresholds	75
Managing Valve purge	76
Miscellaneous	77
Managing Service mode.....	77
Managing Standby action	79
Viewing the Security log	80
Viewing the Diagnostics	80
Managing connection	81
User management	85
Configuring the user roles.....	85
Configuring Home screen (Display Management)	88
Managing display settings.....	89
Reset to default	91
Viewing the system status	92
Managing Setpoints.....	93
Changing the system mode	95
Changing the fan speed	96
Alarms	97
Alarms	97
Alarm notification signs	97
Alarm notification	98

Alarm preference98

Unacknowledged alarms101

List of alarms and their severity103

Managing the alarms.....105

Scheduling109

 About Schedule109

 Setting up a weekly schedule.....110

 Setting up a holiday schedule115

 Special event121

Declaration

This document contains Honeywell proprietary information. Information contained herein is to be used solely for the purpose submitted, and no part of this document or its contents shall be reproduced, published, or disclosed to a third party without the express permission of Honeywell International Inc.

While this information is presented in good faith and believed to be accurate, Honeywell disclaims the implied warranties of merchantability and fitness for a purpose and makes no express warranties except as may be stated in its written agreement with and for its customer.

In no event is Honeywell liable to anyone for any direct, special, or consequential damages. The information and specifications in this document are subject to change without notice.

Copyright 2023 – Honeywell International Inc.

Waste Electrical and Electronic Equipment (WEEE)

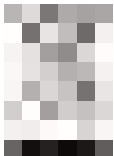
WEEE: Waste Electrical and Electronic Equipment Directive	
	<ul style="list-style-type: none"> • At the end of the product life, dispose of the packaging and product in an appropriate recycling center. • Do not dispose of the device with the usual domestic refuse. • Do not burn the device.

FCC Part 15 compliant

This device complies with part 15 of the FCC Rules. Operation is subject to the following two conditions:

- (1) This device may not cause harmful interference, and
- (2) This device must accept any interference received, including interference that may cause undesired operation.

Regulation (EC) No 1907/2006

According to Article 33 of Reach Regulation, be informed that the substances listed below may be contained in these products above the threshold level of 0.1% by weight of the listed article.

Product/Part Code	Substance Name	CAS Number
Only TC300 thermostat main board CBA, thermostat wall plate board PCBA	Lead	7439-92-1
	Lead oxide	1317-36-8

Important Safety Information and Installation Precautions

Read all instructions

Failure to follow all instructions may result in equipment damage or a hazardous condition. Read all instructions carefully before installing equipment.

When performing any work (installation, mounting, start-up), all manufacturer instructions and in particular the Mounting Instructions (31-00642) are to be observed.

- TC300 Thermostat may be installed and mounted only by authorized and trained personnel.
- It is recommended that devices be kept at room temperature for at least 24 hours before applying power. This is to allow any condensation resulting from low shipping/storage temperatures to evaporate.
- Do not open TC300 Thermostat, as it contains no user-serviceable parts inside!
- Investigated according to United States Standard UL- 60730-1, and UL60730-2-9.
- Investigated according to Canadian National Standard(s) C22.2, No. 205-M1983 (CNL-listed).
- CE declarations according to LVD Directive 2014/35/EU and EMC Directive 2014/30/EU.
- Product standards are EN 60730-1 and EN 60730-2-9.
- TC300 Thermostat is Class B digital apparatus and complies with Canadian ICES-003.

Local codes and practices

Always install equipment in accordance with the National Electric Code and in a manner acceptable to the local authority having jurisdiction.

Electrostatic sensitivity

This product and its components may be susceptible to electrostatic discharge (ESD). Use appropriate ESD grounding techniques while handling the product. When possible, always handle the product by its non-electrical components.

High voltage safety test

Experienced electricians, at first contact, always assume that hazardous voltages may exist in any wiring system. A safety check using a known, reliable voltage



measurement or detection device should be made immediately before starting work and when work resumes.

Lightning and high-voltage danger



Most electrical injuries involving low-voltage wiring result from sudden, unexpected high voltages on normally low voltage wiring. Low-voltage wiring can carry hazardous high voltages under unsafe conditions. Never install or connect wiring or equipment during electrical storms. Improperly protected wiring can carry a fatal lightning surge for many miles. All outdoor wiring must be equipped with properly grounded and listed signal circuit protectors, which must be installed in compliance with local, applicable codes. Never install wiring or equipment while standing in water.

Wiring and equipment separations



All wiring and controllers must be installed to minimize the possibility of accidental contact with other potentially hazardous and disruptive power and lighting wiring. Never place 24VAC or communications wiring near other bare power wires, lightning rods, antennas, transformers, or steam or hot water pipes. Never place wire in any conduit, box, channel, duct or other enclosure containing power or lighting circuits of any type. Always provide adequate separation of communications wiring and other electrical wiring according to code. Keep wiring and controllers at least six feet from large inductive loads (power distribution panels, lighting ballasts, motors, etc.). Failure to follow these guidelines can introduce electrical interference and cause the system to operate erratically.



Warning

By using this Honeywell literature, you agree that Honeywell will have no liability for any damages arising out of your use, or modification to, the literature. You will defend and indemnify Honeywell, its affiliates and subsidiaries, from and against any liability, cost, or damages, including attorneys' fees, arising out of, or resulting from, any modification to the literature by you.

The material in this document is for information purposes only. The content and the product it describes are subject to change without notice. Honeywell makes no representations or warranties with respect to this document. In no event shall Honeywell be liable for technical or editorial omissions or mistakes in this document, nor shall it be liable for any damages, direct or incidental, arising out of or related to the use of this document. No part of this document may be reproduced in any form or by any means without prior written permission from Honeywell.

Safety Information as per EN60730-1

TC300 Thermostat is intended for commercial and residential environments.

TC300 Thermostat is an independently mounted electronic control system with fixed wiring.

TC300 Thermostat is used for the purpose of building HVAC control and is suitable for use only in non-safety controls for installation on or in appliances.

Introduction

This chapter contains brief description of the TC300 thermostat and its hardware specifications.

Related topics

[About TC300 Thermostat](#)

[Features](#)

[Intended audience and assumed knowledge](#)

[Reference documents](#)

[Abbreviation and nomenclature](#)

[Conventions](#)

[Dimensions](#)

[Technical specifications](#)

[Terminal Identification](#)

[Terminal assignment](#)

[Security requirement](#)

About TC300 Thermostat

TC300 Thermostat is an advanced, highly configurable device providing building automation connectivity well-suited for commercial building applications. The product has flexible I/O that will satisfy the needs of most 2-pipe or 4-pipe fan coil applications including floating, modulating, and 6-way Modulating valves plus multi-speed and variable speed fan and various external sensors with a minimum SKU complexity. Other key supported functions include dehumidification w/reheat using an embedded humidity sensor, auxiliary heat functions, and more rapid transitional 2-pipe system seasonal changeover.

This device supports BACnet MS/TP and Modbus communications via RS485 bus as is needed for typical HVAC building control systems. This same bus is used to facilitate future firmware updates and enhanced functionality as they are released to the market.

The integral intelligent control algorithms plus scheduling help to achieve the perfect balance between Energy Efficiency and Comfort. The thermostat utilizes an attractive, color, capacitive-touch screen interface providing an intuitive configuration process with minimal installer training. This functionality is enhanced through the usage of embedded help screens reducing reliance on technical manuals for complex installation.

Features

- Color, capacitive-touch screen display for intuitive, fast commissioning and exceptional user experience.
- Multiple, configurable user types with customizable privileges to prevent unauthorized usage.
- Embedded system monitoring screen for equipment and I/O status.
- Customizable daily schedule for Occupancy set points. Support upto 10 Holidays including floating or specific date. Support up to 10 special events including specific date. For each holiday or special event can configure 3 period of events.
- Advanced commercial control algorithms such as auto changeover.
- Customizable inactive display modes, Auto dim display, always on, or dark mode.
- A LED ring indicator to show the operational status.
- Real-Time Clock time keeping accuracy with 72 hour retention during power loss.
- Thermostat can be configured via HMI, or BACnet.

Equipment control features

- Fan coil, On/Off Valve, Floating Valve, Modulating Valve, and 6-Way Modulating Valve.
- Discharge Air Control
- 1-3 or variable speed fan
- Dehumidification with and without reheat.
- Enhanced 2-Pipe fan coil functionality during seasonal or system changeover providing heating or cooling functionality before CW/HW has reached optimal operating temperature.
- Service mode for manually enabling outputs for faster diagnostics and equipment testing.
- Auxiliary heating options supporting peripheral or supplemental types
- Auto mode to switch between heating and cooling according to the current space temperature

- Staging control, PID Tuning, DAT Lockout, Modulating control
- System Switch and Ventilation options.
- Integration with a variety of external wired sensor types including: Discharge air, Drain pan, occupancy, Proof or airflow, Space temp, CO2, and Humidity.
- Complies with ASHRAE guideline 36-2021, Section 5.22 sequence of operations for high-performance operation when using floating/modulating valves and multi-speed/variable speed fan.

Intended audience and assumed knowledge

This document provides information about installing and commissioning a TC300 Thermostat. It also shows how to operate the user interface.

It is assumed that the user is trained and familiar with HVAC concepts.

IMPORTANT: Always install equipment in accordance with the National Electric Code and in a manner acceptable to the local authority having jurisdiction (AHJ). No guidelines, instructions, installation practices, or other information presented in this guide may be interpreted to supersede or modify the local codes and practices of the AHJ.

Reference documents

- TC300 Commercial Thermostat Datasheet (31-00645)
- TC300 Commercial Thermostat Mounting & Installation instructions (31-00642)
- TC300 Commercial Thermostat Pocket guide (31-00648)
- TC300 Deco Plate Pocket guide (31-00657)
- TC300 BACnet Integration guide (31-00646)
- TC300 Modbus Integration guide (31-00670)

Abbreviation and nomenclature

Abbreviation	Definition
AHU	Air Handling Unit
RTU	Roof Top Unit
VAC	Volts AC (Alternating Current)
VDC/ DC	Volts DC (Direct Current)
OTW	Over-The-Wire
BMS	Building Management System

Conventions

The TC300 thermostat has a 2.4 inch, 320x240 pixel LCD screen for easy navigation and setup. You can select various options available on the screen by lightly tapping the option on the screen or scrolling through the list.

The conventions for hand gestures used to navigate through the screens on the TC300 Thermostat display are:

- Tap: Quickly touch and release to select a control or item; equivalent to a mouse-click.
- Swipe: Quickly slide one or more fingers across the screen to reveal controls or to scroll through lists or groups of items; equivalent to scroll.

Figure 1 Hand gestures convention

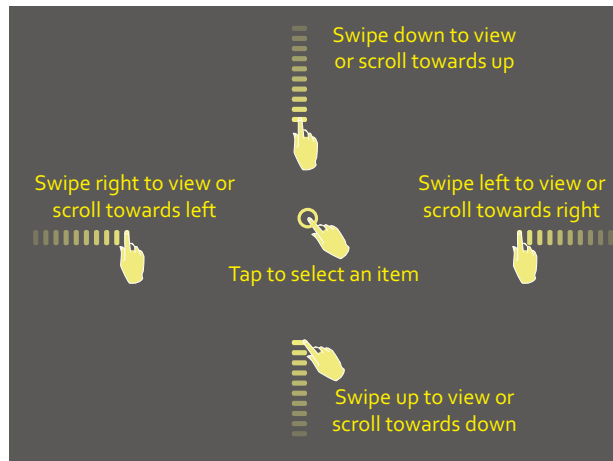

- A green indicator appears before the valid selection
- If the option selected or the text entered is valid, the option to move to the subsequent screen turns blue. Tapping the option in blue will toggle to next screen.

Dimensions

Thermostat

Figure 2 Dimensions

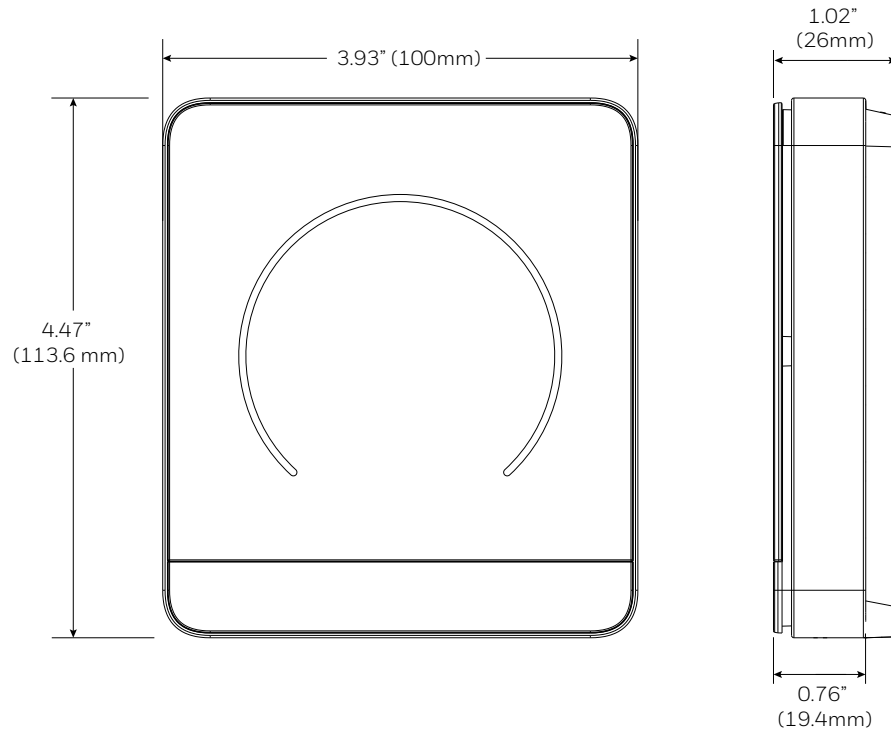

TRTC-DECOPLATE-1

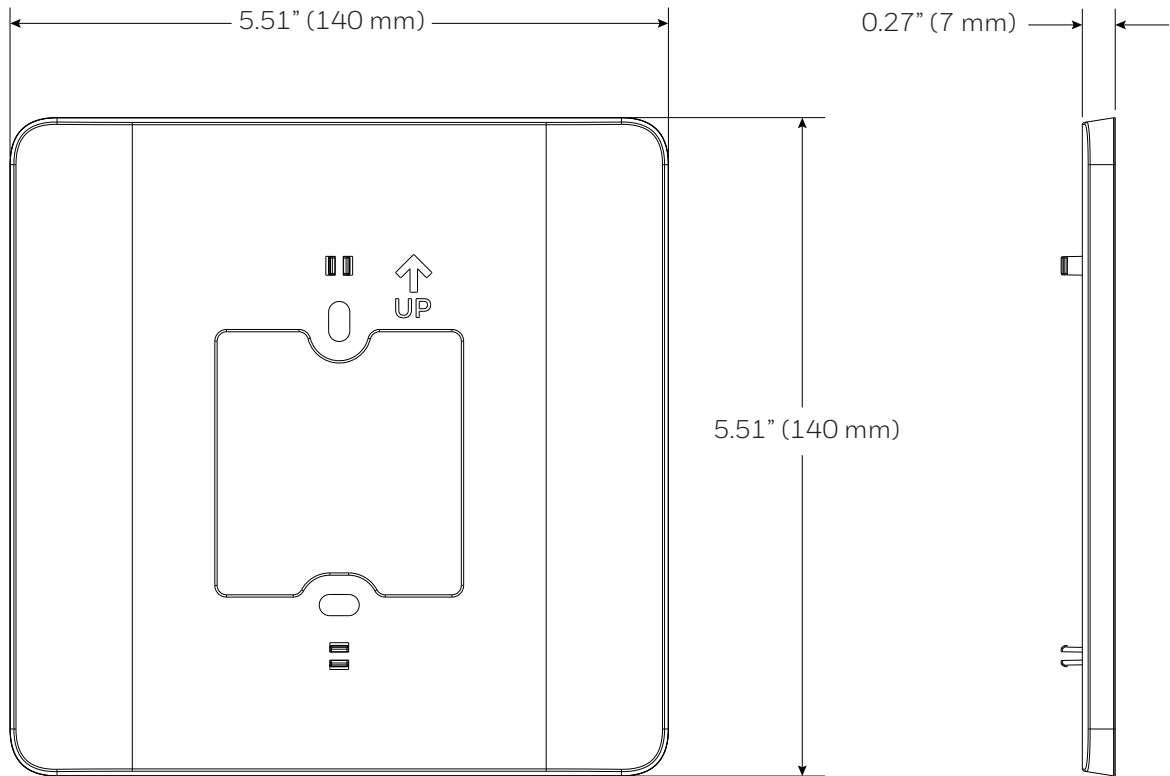

Technical specifications

Power Characteristics

Table 1: Power Characteristics

Power Supply	Rated voltage: 24VAC 50/60Hz, Working voltage range: 20-30VAC, UL listed class-2 transformer or IEC 61558 listed transformer.
Power Consumption (Display ON)	Max. 8.5VA @ 24VAC (355mA @ 24VAC)
Min. Load	4VA (all DOs OFF, No Sylk sensor)
Max. Load	96VA (all DOs ON)

Display

Table 2: Display

Display Type	16 BPP TFT display with CTP
Resolutions	320*240 pixel
Active Display Area	2.4" diagonally
Backlight	LCD (Dimmable)
LED Color Ring	Blue (cooling) Orange (heating)

Operating Environment

Table 3: Operating Environment

Ambient Operating Temperature	32 to 122 °F (0 to 50°C)
Ambient Operating Humidity	10 to 90% relative humidity (non-condensing)
Storage Temperature	-40 to 150 °F(-40 to 65.5°C)
Protection Class	IP20

Compliances

Table 4: Compliances

Certificates	<ul style="list-style-type: none"> • CE • FCC • ICES • UL/cUL • RoHs • REACH • Prop65 • UK
Standards	<ul style="list-style-type: none"> • EN 60730-1 • EN 60730-2-9 • BS EN 60730-1 • BS EN 60730-2-9 • UL60730-1 • UL60730-2-9 • Title 47 part 15 subpart B • ICES-003

IO Characteristics

Table 5: IO Characteristics

UIO x 3	<ul style="list-style-type: none"> • Resistive Temperature Sensor Input <ul style="list-style-type: none"> – NTC10K Type II, C7021 series – NTC10K Type III, C7023 series – NTC20K, TR21, and C7041 series • Voltage Input, SELV <ul style="list-style-type: none"> – 0-10V, $\pm 5\%$ of full scale • Digital Input <ul style="list-style-type: none"> – Dry contact closure – Open circuit ($\geq 100\text{Kohms}$) – Closed circuit ($\leq 100\text{ohms}$) • Voltage Output <ul style="list-style-type: none"> – 0-10V, $\pm 3\%$ of full scale @2K ohms
AI (DIO1 DIO2) x 2	<ul style="list-style-type: none"> • Resistive Temperature Sensor Input <ul style="list-style-type: none"> – NTC10K Type II, C7021 series – NTC10K Type III, C7023 series – NTC20K, TR21, and C7041 series • Digital Input <ul style="list-style-type: none"> – Dry contact closure – Open circuit ($\geq 100\text{Kohms}$) – Closed circuit ($\leq 100\text{ohms}$)
DO1-3, DIO1-2	<ul style="list-style-type: none"> • Relay Output • Rated Average Current <ul style="list-style-type: none"> – 1A Resistive at 24VAC • Rated Pulse Current <ul style="list-style-type: none"> – 3.5A Resistive at 24VAC

Onboard Sensors

Table 6: Onboard Sensors

Temperature	Heat: 40 to 100°F (4.5 to 37.7°C) Cool: 50 to 99°F (10 to 37°C) Resolution: 1 °F (0.5°C) Control Accuracy: $\pm 1.5^\circ\text{F}$ (0.8°C) at Room Temperature
Humidity	Range: 20~90% RH Resolution: 1%RH Control Accuracy: $\pm 5\%$ RH at Room Temperature and 20~90%RH

Communication Technologies

Table 7: Communication Technologies

Sylk™	Honeywell Sylk™
BACnet MS/TP	Over RS485 (9.6, 19.2, 38.4, 76.8, 115.2 Kbps)
Modbus RTU	1.2 to 115.2 Kbps

Electrical Characteristics

Table 8: Electrical Characteristics

Rated Impulse Voltage	500 V
Construction of Control	Independently Mounted Control
Operation Method	Type 1.B Action
Pollution Degree	2
Purpose of Control	Operating Control

Supported Sensors and Functions

Table 9: Supported Sensors

Sensors	Options	Part Numbers
Occupancy Sensor	Direct (Normally Open) Reverse (Normally Closed)	Dry contact occupancy sensor
Proof Of Air Flow Sensor	Direct (Normally Open) Reverse (Normally Closed)	DPS200 DPS400 DPS1000 MCS, CS, CSP current switches (Dry contact switches)
Discharge Air Temperature Sensor	NTC 20K NTC 10K Type II NTC 10K Type III Sylk	C7250A C7041 C7021 C7023 C7400S
Space Temperature Sensors	NTC 20K NTC 10K Type II NTC 10K Type III Sylk	TR21 C7041, C7772A, C7021, C7772F, C7023, C7772G, TR40, TR40-H, TR40-CO2, TR40-H-CO2, TR50-3N, TR50-3D

Table 9: Supported Sensors

Sensors	Options	Part Numbers
Changeover Pipe Sensor	NTC 20K NTC 10K Type II NTC 10K Type III	C7250A C7041 C7021 C7023
Changeover Switch	Closed with heat Closed with cool	Digital input
Drain Pan / Leak Detector	Direct (Normally Open) Reverse (Normally Closed)	Dry contact float switch or water sensor

Part Numbers

Table 10: Part Numbers

TC300B-G	RS485 BACnet MS/TP and Modbus
TRTC-DECOPLATE-1	TC300 deco plate for NA junction boxes

Terminal Identification

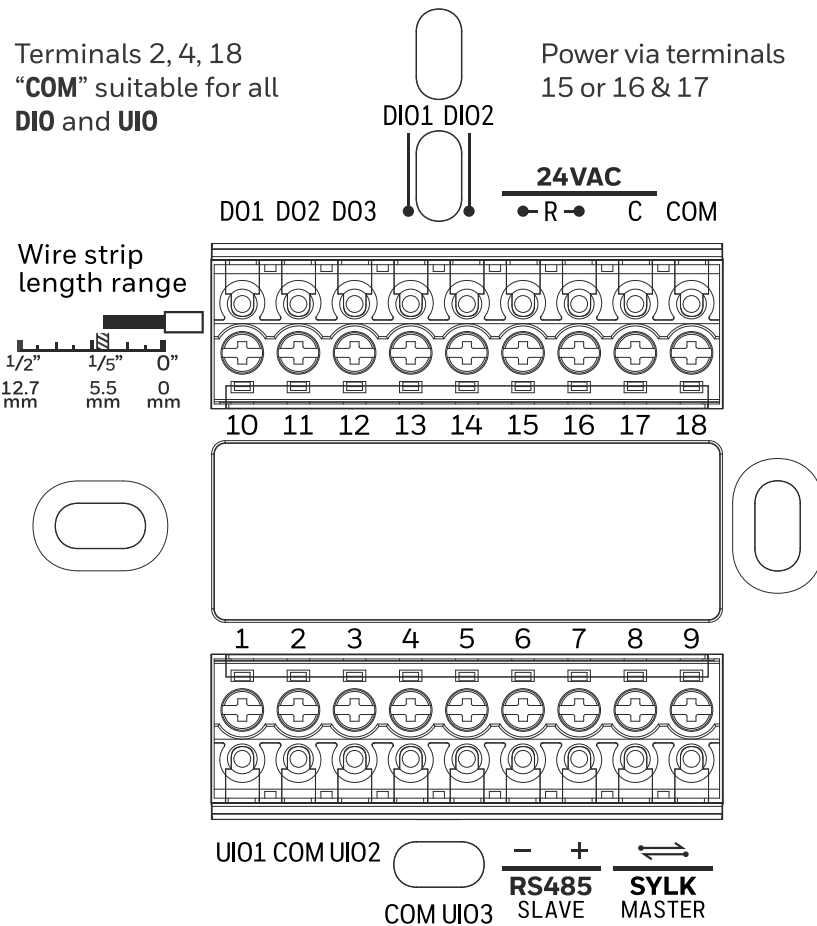

Table 11: Terminal Identification



Terminal Name	Terminal Label	Description
UIO1	UIO1	Universal input/output
COM	COM	Common
UIO2	UIO2	Universal input/output
COM	COM	Common
UIO3	UIO3	Universal input/output
RS485 SLAVE	-	BACnet/Modbus Communications
RS485 SLAVE	+	BACnet/Modbus Communications
SYLK MASTER		Sylk bus
SYLK MASTER		Sylk bus

Table 11: Terminal Identification (Continued)

Terminal Name	Terminal Label	Description
DO1	DO1	Configurable relay output
DO2	DO2	Configurable relay output
DO3	DO3	Configurable relay output
DIO1	DIO1	Configurable relay output, configurable analog/relay input
DIO2	DIO2	Configurable relay output, configurable analog/relay input
24VAC POWER	R	24VAC power from Class2 transformer
24VAC POWER	C	24VAC common (Neutral) from Class2 transformer
COM	COM	Common

Terminal assignment

Table 12: Terminal assignment

Type	Terminal	Label	Terminal Assignments		
			Default	Inputs	Outputs
Digital Output	DO1	DO1	On/Off Heat	NA	Heating On/Off, Heating Floating Open, Cooling Floating Open, Valve On/Off, Valve Floating Open, Changeover Valve, Fan Command, High Speed Fan, Medium Speed Fan, Low Speed Fan, Auxiliary Heat, Heat Stage1, Valve Stage1 Note: Changeover valve used to switch between heating and cooling mode.
	DO2	DO2	On/Off Cool	NA	Heating Floating Close, Cooling Floating Close, Cooling On/Off, Valve Floating Close, Changeover Valve, Fan Command, High Speed Fan, Medium Speed Fan, Low Speed Fan, Auxiliary Heat, Cool Stage1
	DO3	DO3	NA	NA	Cooling Floating Open, Changeover Valve, Fan Command, High Speed Fan, Medium Speed Fan, Low Speed Fan, Auxiliary Heat, Heat Stage1, Cool Stage1
	DIO1	DIO1	NA	Discharge Air Sensor, Drain Pan Sensor, Occupancy Sensor, Proof of Airflow, Pipe Sensor, Space Temp Sensor, Changeover Switch	Cooling Floating Close, Changeover Valve, Fan Command, High Speed Fan, Medium Speed Fan, Low Speed Fan, Auxiliary Heat
	DIO2	DIO2	NA	Discharge Air Sensor, Drain Pan Sensor, Occupancy Sensor, Proof of Airflow, Pipe Sensor, Space Temp Sensor, Changeover Switch	Changeover Valve, Fan Command, High Speed Fan, Medium Speed Fan, Low Speed Fan, Auxiliary Heat
Universal Input/ Output	UIO1	UIO1	NA	Discharge Air Sensor, Drain Pan Sensor, Occupancy Sensor, Proof of Airflow, Pipe Sensor, Space Temp Sensor, Changeover Switch	6-Way Valve, Modulating Cool, Modulating Heat, Modulating Valve, Variable Speed Fan
	UIO2	UIO2	NA		
	UIO3	UIO3	NA		

Security requirement

System Environmental Considerations

An Internet firewall is required to isolate the Thermostat. Unprotected Internet connections can expose and damage the thermostat system and facility components to cyber-attacks from third parties. This may cause the thermostat to malfunction and can also be misused for illegal purposes for which the operator may then be held liable.

Deployments and Maintenance Considerations

- Always keep the local server up to date on the latest security patches via a regular system update. This applies not only to workstations or servers running on Windows, Linux, Mac, or any devices that run as part of information infrastructure or operations workstation.
- Always keep the thermostat firmware with the latest released firmware to have maximum protection by built-in security features.
- Do not use default passwords for any devices (if exists). This includes, but not limited, to all server workstations, storage servers, firewall devices, routers, and mobile devices.
- Do not use weak passwords for server administrators or operators. Different user roles (for example administrator, user, guest, etc.) shall have a different password, and the user should not share common passwords.
- In case of wireless communication, malicious wireless devices can easily scan the wireless channel and inject malicious packets or mass data flow to perform Denial-of-Service attacks. Honeywell has taken steps to prevent the TC300 Commercial Thermostat device from being injected, but the mass data flow will result in the loss of wireless communication bandwidth within the whole system. A regular check of the communication failure rate or response rate of the thermostat is helpful to discover and isolate devices being attacked and stop the physical attacks in the daily operation

Network Communication Notice

- To keep maximum integration compatibility with third-party devices and Fast-pack communications are un-encrypted as open protocol. Improper security protection may lead to data leakage, spoofing, and/or tampered by malicious devices and denial-of-service attacks.
- To keep maximum integration compatibility with legacy devices, in-room wired devices are less secure from data confidentiality and authentication thus not-recommended for a new design. It is always highly recommended to use deep mesh wireless network communication to gain maximum protection and the latest updates.
- In case of Denial-of-Service attacks, all communication channels will inevitably have a loss of bandwidth due to malicious data flow.
- Connected devices may contain legacy technology, which is less secure under modern cyber-security attacks. Honeywell strongly recommends using a secured deep mesh wireless network communication. In case of legacy technology, the user needs to be aware of the risk of being tampered with or attacked. To reduce the attack surface, the user is advised to physically secure the wired communication signals or provide necessary shield on wires, or place necessary access control on accessing such communication wires.

Overview

This chapter describes the TC300 Thermostat display, home screens, icons, and other user interfaces. For mounting the TC300 Thermostat, refer to TC300 Thermostat Mounting instructions (31-00642).

Related topics

[Home screen: Temperature reading and adjustment](#)

[Quick access screen \(right side screen\): Device configuration](#)

[Ambiance screen \(left side screen\): Sensor reading](#)

[Home screen icon overview](#)[Inactive display modes](#)

[Inactive display modes](#)

[Display timeout properties](#)

Home screen: Temperature reading and adjustment

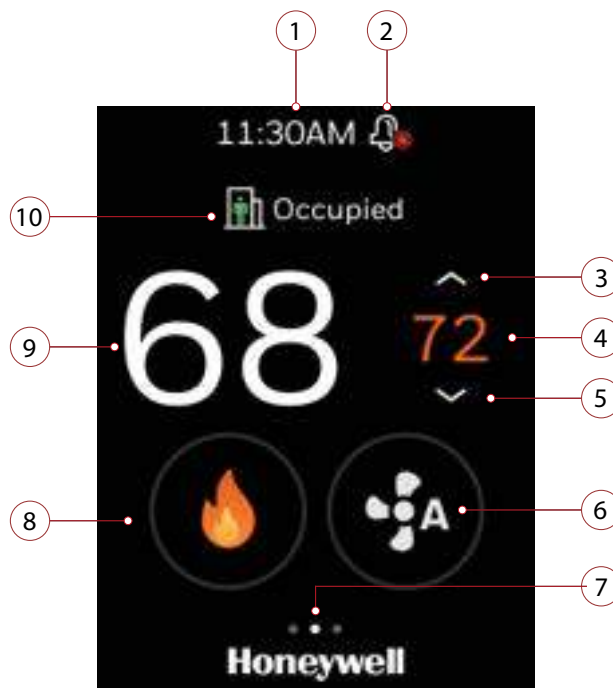

Table 13: Home screen (main screen) Overview

Item	Description
1	Time
2	Alarm status
3	Adjust temperature: Touch the up arrow to increase the desired temperature.
4	Desired temperature: Displays the desired temperature.
5	Adjust temperature: Touch the down arrow to decrease the desired temperature.
6	Fan Speed: Indicates current Fan speed for Fan Coil unit. Tap to change the fan speed.
7	Home screen indicator: Use finger to swipe to left or right to display more options.
8	System Mode Display: Orange flame for heat mode, blue snowflake for cool mode.
9	Indoor Temperature: Displays the current indoor temperature.
10	Current Schedule: Indicates the current Occupant status (Occupied, Unoccupied, Standby, Temporary)

Quick access screen (right side screen): Device configuration

Swipe left from the home screen to view the Quick access screen.

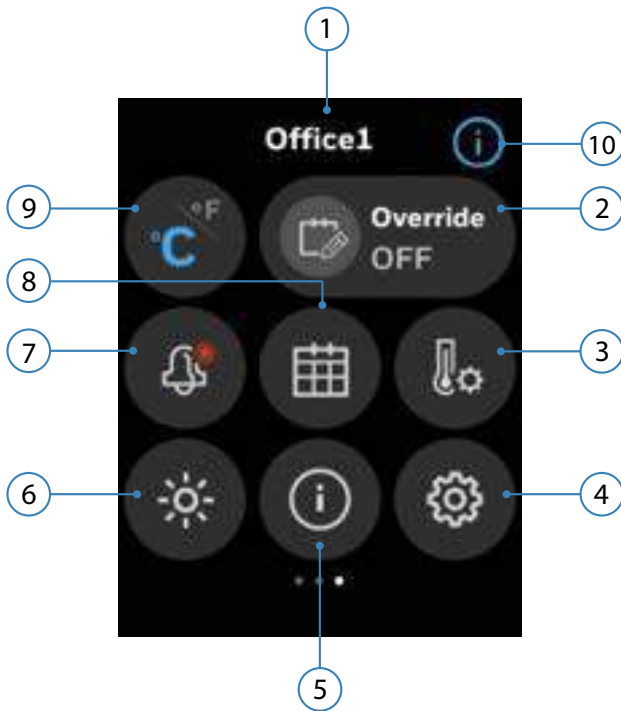

Table 14: Quick access screen

Item	Description
1	The name assigned to the thermostat while performing initial set up.
2	Override: Override unoccupied or standby modes to allow setpoint adjustments.
3	Setpoint: Configure the set points of various parameters.
4	Config: Configure the thermostat.
5	System Status: See the system status of various equipment (moved from Config menu)
6	Brightness: Increase or decrease the brightness of the display.
7	Alarm: View active alarms.
8	Schedule: Set the schedules.
9	Temperature Units: Toggle between Fahrenheit or Celsius.
10	Help icon: User help information for the options available on the screen.

Ambiance screen (left side screen): Sensor reading

Swipe right from the home screen to view the Ambiance screen. Establish Internet connection with thermostat, setup the location or connect to outdoor sensors to display the humidity and outdoor temperature. See [Initial Configuration](#).

Figure 3 Ambiance screen (left side screen)



Note: The types of reading displayed varies according to the sensor connected to the thermostat.

To configure the ambiance screen, see [Configuring Home screen \(Display Management\)](#).

Table 15: Typical ambiance screen













Description
Indoor CO2 level (ppm)
Indoor humidity%

Home screen icon overview

Table 16: Home Screen Icon Overview

Icon	Description
	High severity alarm
	Medium severity alarm
	Auto mode
	Heating mode

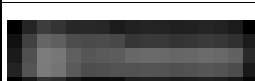
Table 16: Home Screen Icon Overview

Icon	Description
	Cooling mode
	Ventilation mode
	System off
	Fan auto
	Fan speed low
	Fan speed medium
	Fan speed high
	Fan circulate
	Occupied mode
	Standby mode
	Unoccupied mode
	Temporary mode
	Permanent mode

Active display modes

Figure 4 Active display modes



Inactive display modes

Figure 5 Inactive display modes



Note: To configure the ring LED and display, see [Managing display settings](#).

Display timeout properties

Table 17: Display timeout properties

LCD back light behavior	Time	Mode	LCD back light brightness (0-100, pwm)	LED back light brightness (0-100, pwm)
Wakes up when user touch the screen	Instant	Normal/Disable LCD Off/Enable dark mode	80%	10%

Table 17: Display timeout properties (Continued)

LCD back light behavior	Time	Mode	LCD back light brightness (0-100, pwm)	LED back light brightness (0-100, pwm)
Dimmer when no user activity	In 10 seconds	Normal/Disable LCD Off/Enable dark mode	10%	10%
Off/black when no user activity	In 30 seconds	Normal	0%	80%
		Disable LCD off	10%	80%
		Enable dark mode	0%	0%
Return to home screen - During initial setup	In 35 seconds	-	-	-

Getting Started

This chapter contains steps and descriptions to set up the initial configuration of the thermostat and other basic configurations.

Related topics

[Prerequisites](#)

[Boot-up the thermostat](#)

Prerequisites

Before going through initial guided setup sequences, ensure the TC300 is installed and wired up according to the TC300 installation and mounting guide.

WARNINGS

- To reduce the risk of electrical shock do not open the thermostat. There are no user-serviceable parts inside. Refer servicing to qualified service personnel only.
- Cleaning — Use a dry cloth to clean the product. Do not use liquid cleaners or aerosol cleaners
- Water and moisture — Do not use the product near water. Do not install the product in a place where water may splash onto it.
- Do not operate the thermostat with a hard, sharp, or pointed object such as a fingernail, pen.
- The screen used for the thermostat is made of glass. Therefore, it can break when the product is dropped or heavy impact is applied. Do not handle broken glass without appropriate protection in event of damage.

Boot-up the thermostat

The thermostat will be powered up automatically after it mounted on the wallplate. You will navigate through the settings given below subsequently while setting up the thermostat.

[Assigning a name to the thermostat](#)

[Connecting to network](#)

[Selecting a temperature unit](#)

[Setting Date and Time](#)

[Setting up the Equipment type](#)

[Setting up the System switch](#)

[Configuring the Schedule](#)

[Setting up the Installer Passcode](#)

[Configuring the Service Info](#)

To set up the thermostat

1. Boot-up the thermostat.

The Honeywell logo screen appears, followed by the “Welcome to TC300” screen.

Figure 4 Welcome screens



The Welcome screen followed by the LET'S BEGIN screen appears.

Figure 5 Welcome screen

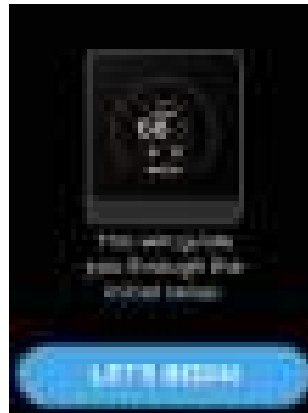

2. Tap **LET'S BEGIN**.
The Device Name appears.

Assigning a name to the thermostat

Figure 6 Device Name

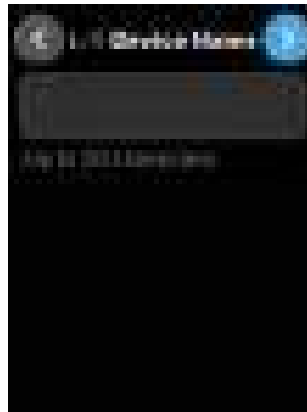

3. Tap on the text field
A keyboard will be displayed on the screen to enter the device name.
4. Enter the device name.
Assign a unique name to a thermostat specifying a name to the location where the thermostat is installed. It assists the user to easily identify the device during remote operation of the thermostat.
5. After entering a valid device name tap the right arrow button.
The device name is saved and the Connection screen appears.

Connecting to network

Figure 7 Connection



6. If no connection is required, tap **SKIP** or tap the right arrow button. If connection is required, the connection screen appears.

Figure 8 Connection



7. Tap **BACnet MS/TP** and enable the MSTP connection. See [Managing connection](#).
8. Tap **Modbus** and enable the Modbus connection. See [Managing connection](#). The General screen appears.

Selecting a temperature unit

Figure 9 Temperature unit



9. Select a preferred temperature unit.
10. Set the **Date & Time**. See [Setting Date and Time](#)

Setting Date and Time

Figure 10 Date and Time Configuration screen

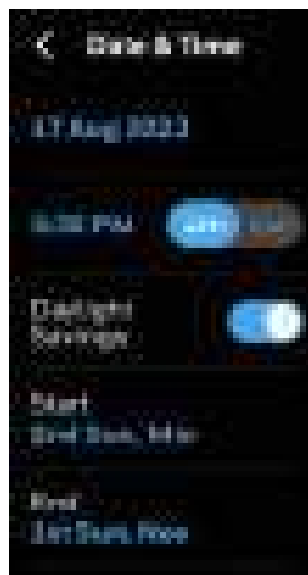

11. Tap the date to set the today's date.
12. Slide the Display toggle button to the right to set the 24h time format if required.
13. Enable **Daylight Savings** if required.
14. If Daylight saving is enabled, set the start and end date schedules for daylight savings.
15. After setting date and time, navigate back to General screen and tap the right arrow button.
The Equipment and I/O screen appears.

Setting up the Equipment type

The TC300 is designed to control Fan coil units. It can control 4 pipe dual coil, 4 pipe single coil, and 2 pipe single coil.

Figure 11 Equipment and I/O



16. Tap **Equipment** and set the equipment details. See [Equipment configuration](#).
17. Tap **I/O Assignment** and assign the I/Os. See [I/O terminal assignment](#).
18. Tap the right arrow button.
The System Switch screen appears.

Setting up the System switch

The operation mode of system switch depends on the equipment configuration.

Figure 12 System Switch



19. Set the required parameters and tap the right arrow button.
The Setpoints screen appears.

Figure 13 Setpoints



20. Configure the **Occupied**, **Standby**, and **Unoccupied** setpoints. See [After set up the thermostat device, you can re-configure the user management equipment, schedules, alarms, and terminal assignments. To reconfigure initial setup, refer to Device Configuration & Equipment Settings.](#)
21. After configuring the setpoints, tap the right arrow button on the Setpoint screen to move to next screen.
The Passcode screen appears.

Setting up the Installer Passcode

Figure 14 Passcode



22. Tap on the text field
A keyboard will popup.
23. Enter a passcode.
Note: The passcode must contains 4 to 12 characters including a Alpha/numeric/symbol character.
24. Tap the right arrow button.
The Service Info screen appears.
Note: The Installer passcode is to prevent unauthorized changes to thermostat settings. This passcode will be needed to enter into locked menu's, such as Advanced

Configuration.

Configuring the Service Info

Figure 15 Service Info



25. Enter the service personnel information.
26. Tap the right arrow button.
The Congratulations message appears.

Figure 16 Successful connection



27. Tap **DONE**.
The User Management screen appears.

Figure 17 User management



28. Tap **YES** to configure the user list. See

29. Tap **No** to start using the thermostat.

Thermostat Home screen appears.

Figure 18 Home screen

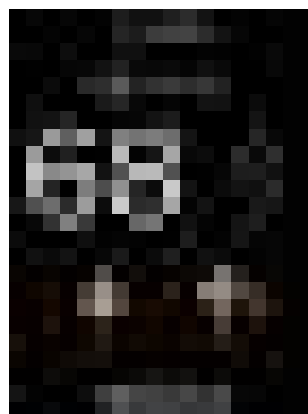

After set up the thermostat device, you can re-configure the user management equipment, schedules, alarms, and terminal assignments. To reconfigure initial setup, refer to [Device Configuration & Equipment Settings](#).

Configuration

This chapter contains thermostat level configuration and equipment level configuration procedures. Only the Installer has access to these configuration screens.

Related topics

- [Configuration screen](#)
- [Basic configuration](#)
- [Equipment configuration](#)
- [I/O terminal assignment](#)
- [Configuring sensors](#)
- [Managing System switch](#)
- [Managing Discharge air control](#)
- [Managing Dehumidification](#)
- [Managing Valve cycle](#)
- [Advanced configuration](#)
- [Managing Setpoint options](#)
- [Managing Cooling options](#)
- [Managing Heating options](#)
- [Managing Pipe sensor thresholds](#)
- [Managing Valve purge](#)
- [Miscellaneous](#)
- [Managing Service mode](#)
- [Managing Standby action](#)
- [Viewing the Security log](#)
- [Viewing the Diagnostics](#)
- [Managing connection](#)
- [User management](#)
- [Configuring the user roles](#)

[Configuring Home screen \(Display Management\)](#)

[Managing display settings](#)

[Reset to default](#)

[Viewing the system status](#)

[Managing Setpoints](#)

[Changing the system mode](#)

[Changing the fan speed](#)

Configuration screen

The configuration screen displays all the configuration items of the thermostat and equipment.

1. Swipe left from the Home screen.
2. On the Quick access screen, tap the configuration  button.
The Configuration screen appears.

Figure 19 Configuration screen



Basic configuration

The Basic Configuration includes options to configure the thermostat setting such as Device Name, Date and Time, Screen Cleaning, Override Setting, and Service Info. You might have configured these configurations while setting up the thermostat. However, you can change the configuration here again.

Figure 20 Basic configuration



The following features are covered under the Basic configuration.

[To rename the device name](#)

[To configure Date & Time](#)

[To enable screen cleaning mode](#)

[To configure override setting](#)

[To modify service info](#)

To rename the device name

1. Swipe left from the Home screen.
2. On the Quick access screen, tap  > **Basic** > **Device Name**.
The Device name screen appears.

Figure 21 Naming the thermostat

3. Tap on the text field
A keyboard will be displayed on the screen to enter the device name.
4. Enter the device name.
Assign a unique name to a thermostat specifying a name to the location where the thermostat is installed. It assists the user to easily identify the device during remote operation of the thermostat.
5. Tap the back button to navigate back to the previous screen and save the settings.

To configure Date & Time

The date and time of the thermostat is must be set manually. You can configure the Date & time and Daylight savings.

1. Swipe left from the Home screen.
2. On the Quick access screen, tap  > **Basic** > **Date and Time**.
The Date & Time screen appears.

Figure 22 Date & Time

3. Tap the date to set the today's date.
4. Slide the Display toggle button to the right to set the 24h time format if required.

5. Enable **Daylight Savings** if required.
6. If Daylight saving is enabled, set the start and end date schedules for daylight savings.
7. Tap the back button to navigate back to the previous screen.

To enable screen cleaning mode

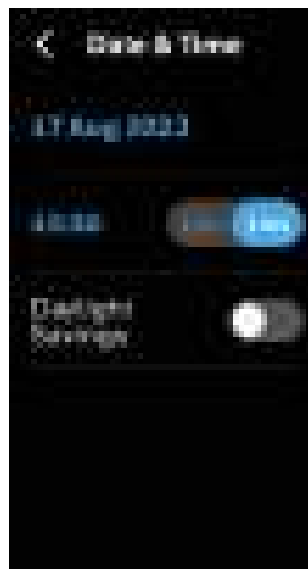
Screen cleaning mode lock/disable the touch sensitivity of the display for 30 seconds so you can clean the device display while the thermostat is functional.

1. Swipe left from the Home screen.
2. On the Quick access screen, tap  > **Basic** > scroll down > **Screen Cleaning**.
The Screen Cleaning screen appears.

Figure 23 Screen cleaning



3. Tap **OK** to enable the screen cleaning mode for 30 seconds or tap the back button to navigate back to the previous screen.

To configure override setting

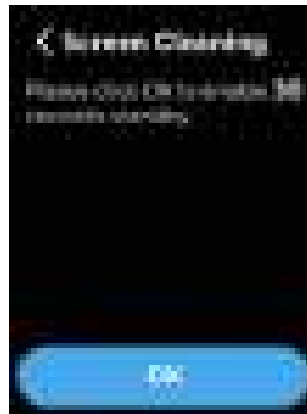
This is to allow the user to configure the override settings. There are two types of override settings available.

Permanent Override - This provides schedule for 24/7 fixed setpoint control (No occupied, standby periods).

Temporary Override - This allows authorized user to adjust setpoint or operating mode for fixed interval that deviates from standard schedule.

The override occurs when the user manually changes the setpoint on the thermostat screen. This overcomes the current mode from Occupied/Unoccupied/Standby to temporary mode.

1. Swipe left from the Home screen.
2. On the Quick access screen, tap  > **Basic** > scroll down > **Override Setting**.
The Override Setting screen appears.

Figure 24 Override setting

3. Tap **Temporary Override** to set the temporary overrides when the user override the setpoint. The temporary override is default.
The Temporary override screen appears.

Figure 25 Temporary override

4. Set the time limit that temporary override should last. After this time, setpoint return to the scheduled mode.
5. To make the override permanent, set the override settings as Permanent override.

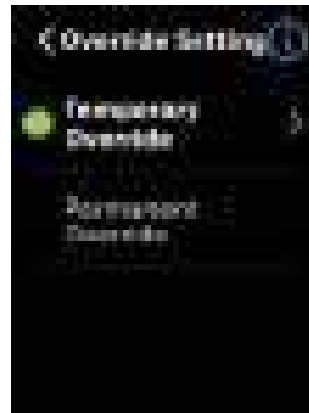
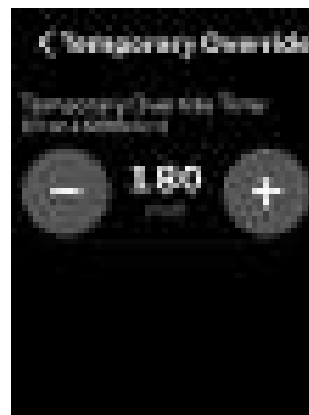
To modify service info

Service info contains the maintenance/installer/contractor personnel who provides the periodic maintenance service. To add/modify the details, follow the procedure given below.

1. Swipe left from the Home screen.
2. On the Quick access screen, tap  > **Basic** > scroll down > **Service Info**.
The Service info screen appears.

Figure 26 Service information

3. Update the name and phone number of the service personnel.
4. Tap the back button to navigate back to the previous screen and save the modified information.

Equipment configuration

The equipment tab provides options to configure the equipment and devices connected to the thermostat. It also provides options control advanced settings like Discharge air control, Dehumidification, Cooling, Heating, System switch, and Sylk devices settings.

To access Equipment screen

1. Swipe left from the Home screen.
2. On the Quick access screen, tap  > **Equipment**.
The Equipment screen appears.

Figure 27 Equipment screen



To configure equipment and I/O

1. Swipe left from the Home screen.
2. On the Quick access screen, tap  > **Equipment** > **Equipment & I/O**.
The Equipment screen appears.

Figure 28 Equipment and I/O



3. Tap **Equipment**.
The second screen of Equipment & I/O appears. It provides options to configure Equipment type, Fan type, Sensors, and Aux heat.

Figure 29 Equipment and I/O types**To configure the type of the equipment**

TC300 thermostat provides options to control three equipment types such as 4-pipe dual coil, 4-pipe single coil, and 2-pipe single coil. Here, you configure the cooling valve, heating valve types, floating and modulating controls.

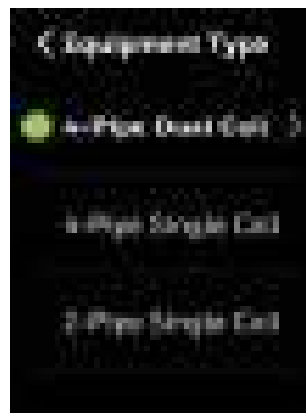
Figure 30 Equipment type

4-Pipe Dual Coil

1. Tap **4-Pipe Dual Coil**.

The 4-Pipe Dual Coil screen appears.

Table 19: 4-Pipe dual coil

Valve type	Valve operation	Options	Sub options	Description
Cooling Valve	On/Off	Normally closed		Set Valve output type as N.C
		Normally Open		Set Valve output type as N.O
	Floating			<ul style="list-style-type: none"> Set the output type as Direct or Reverse Set Valve run time Set Min position when enabled Enable sync at mid night
	Modulating	Control	Modulating control	<ul style="list-style-type: none"> Set min output when enabled. Use Stage 1 cool as enable.
		Setting	Modulating setting	<ul style="list-style-type: none"> Set output type Direct or Reverse Set Min output of Modulating valve Set Max output of Modulating valve
Heating Valve	On/Off	Normally closed		Set Valve output type as N.C
		Normally Open		Set Valve output type as N.O
	Floating			<ul style="list-style-type: none"> Set output type as Direct or Reverse Set Valve run time Set Min position when enabled Enable sync at mid night
	Modulating	Control	Modulating control	<ul style="list-style-type: none"> Set min output when enabled. Use Stage 1 heat as enable.
		Setting	Modulating setting	<ul style="list-style-type: none"> Set output type Direct or Reverse Set Min output of Modulating valve Set Max output of Modulating valve

4-Pipe Single Coil

2. Tap 4-Pipe Single Coil.

The 4-Pipe Single Coil screen appears.

Table 20: 4-Pipe single coil

Valve type	Valve operation/ Output	Options	Description
Regulating and changeover	On/Off	Normally open	Set Valve output type as N.C
		Normally close	Set Valve output type as N.O
	Floating	-	<ul style="list-style-type: none"> Set output type Direct or Reverse Set output type Direct or Reverse Set Min position when enabled Enable sync at mid night
		Modulating	Modulating control Modulating setting
Changeover	Energize on heat	-	Set Changeover relay type
	Energize on cool	-	Set Changeover relay type
6-Way Valve	2-10V	Cooling Range	<ul style="list-style-type: none"> Configure Min Output for Cooling Configure Max Output for Cooling Tap the Info icon to view the minimum allowed deadband range
		Heating Range	<ul style="list-style-type: none"> Configure Min Output for Heating Configure Max Output for Heating
		Reverse	Exchange the heating range and cooling range
	0-10V	Cooling Range	<ul style="list-style-type: none"> Configure Min Output for Cooling Configure Max Output for Cooling Tap the Info icon to view the minimum allowed deadband range
		Heating Range	<ul style="list-style-type: none"> Configure Min Output for Heating Configure Max Output for Heating
		Reverse	Exchange the heating range and cooling range

Note: If Output is set to 0-10 Vdc

- Heating Range: 0.0-4.7 Vdc
- Cooling Range: 5.3-10.0 Vdc
- Off voltage is 4.7-5.3Vdc

If *Output is set to 2-10 Vdc*

- Heating Range: 2.0-5.7 Vdc
- Cooling Range: 6.3-10.0 Vdc
- Off voltage is 6.0 Vdc

2-Pipe Single Coil

3. Tap **2-Pipe Single Coil**.
The 2-Pipe Single Coil screen appears.

Table 21: 2-Pipe single coil

Heating/Cooling type	Controls	Options	Description
Changeover	Pipe sensor		Set the pipe sensor as input value for changeover method.
	Network Input		Set the network input as input value for changeover method.
	Changeover Switch		Set the digital input as input value for changeover method.
Heat & Cool	On/Off	Normally closed	<ul style="list-style-type: none"> • Set Valve output type as N.C
		Normally open	<ul style="list-style-type: none"> • Set Valve output type as N.O
	Floating		<ul style="list-style-type: none"> • Set output type Direct or Reverse • Set Valve run time • Set Min position when enabled • Enable sync at mid night
	Modulating	Control	<ul style="list-style-type: none"> • Set min output when enabled • Use Stage 1 as enable
		Setting	<ul style="list-style-type: none"> • Set output type Direct or Reverse • Set Min output of Modulating valve • Set Max output of Modulating valve
Heat only	On/Off	Normally closed	<ul style="list-style-type: none"> • Set Valve output type as N.C
		Normally open	<ul style="list-style-type: none"> • Set Valve output type as N.O
	Floating		<ul style="list-style-type: none"> • Set output type Direct or Reverse • Set Valve run time • Set Min position when enabled • Enable sync at mid night
	Modulating	Control	<ul style="list-style-type: none"> • Set min output when enabled • Use Stage 1 heat as enable
		Setting	<ul style="list-style-type: none"> • Set output type Direct or Reverse • Set Min output of Modulating valve • Set Max output of Modulating valve

Table 21: 2-Pipe single coil

Heating/Cooling type	Controls	Options	Description
cool only	On/Off	Normally closed	<ul style="list-style-type: none"> Set Valve output type as N.C
		Normally open	<ul style="list-style-type: none"> Set Valve output type as N.O
	Floating		<ul style="list-style-type: none"> Set output type Direct or Reverse Set Valve run time Set Min position when enabled Enable sync at mid night
	Modulating	Control	<ul style="list-style-type: none"> Set min output when enabled Use Stage 1 cool as enable
Setting		<ul style="list-style-type: none"> Set output type Direct or Reverse Set Min output of Modulating valve Set Max output of Modulating valve 	

To configure the fan type

- Swipe left from the Home screen.
- On the Quick access screen, tap  > **Equipment** > **Equipment & I/O** > **Equipment** > **Fan Type**.
The Fan Type screen appears.

Figure 31 Fan type



- Select a fan speed.

Note: The desired option may be “grayed-out” whenever there are insufficient outputs to support this function. Verify I/O is configured appropriately.

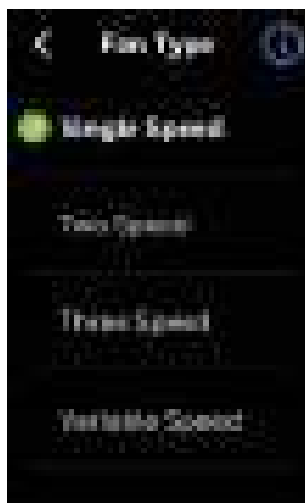
To configure sensors

- Swipe left from the Home screen.
- On the Quick access screen, tap  > **Equipment** > **Equipment & I/O** > **Equipment** > **Sensors**.
The Sensors screen appears.

Figure 32 Sensors



3. Tap the required sensor, relevant sub menu appears to select the settings.

Note: The desired option may be “grayed-out” whenever there are insufficient outputs to support this function. Verify I/O is configured appropriately.

To configure Auxiliary heat

1. Swipe left from the Home screen.
2. On the Quick access screen, tap  > **Equipment** > **Equipment & I/O** > **Equipment** > **Auxiliary Heat**.
The Mode screen appears.

Figure 33 Mode screen



3. Set the Peripheral and Supplemental values.

Peripheral heat runs in conjunction with main fan heat cycle for improved comfort and is performed by external radiant or other heating resources.

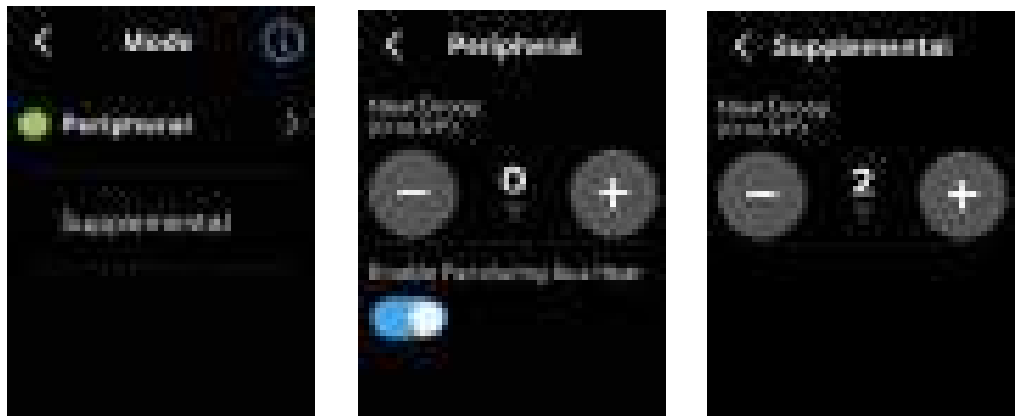
Supplemental heat is a form of staged heating that is only initiated when primary fan coil heat function cannot maintain heating setpoint. It is also used in 2-pipe systems for heating whenever system mode is restricted to cooling only based on water temperature.

I/O terminal assignment

After connecting the thermostat to equipment, you must configure certain terminals in the thermostat so it can identify the correct purpose and apply the appropriate control schemes. The Configurable I/O tab provides options configure thermostat to the equipment and sensors wired to it. For more information on terminal assignments, refer to [Terminal assignment](#) section.

1. Swipe left from the Home screen.
2. On the Quick access screen, tap  > **Equipment** > **Equipment & I/O** > **I/O Assignment**
The I/O Assignment screen appears.

Figure 34 I/O Assignment

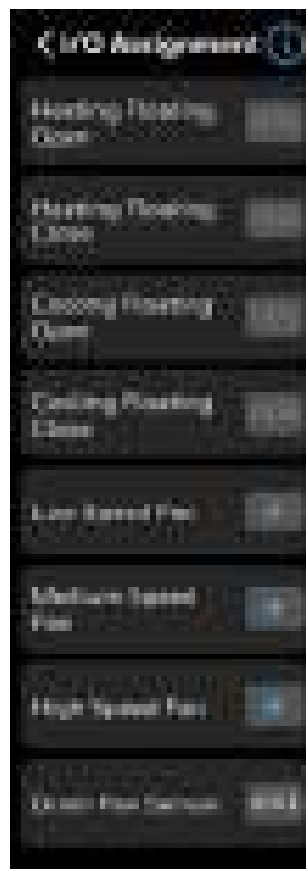

Note: The options available on the above screen varies based on the configured equipment.

3. Tap the plus button to assign the terminals.

Figure 35 Terminals



- Based on selected equipment function the terminals will be pre-assigned. To override default terminal assignment select alternate(s) as required.
- If a terminal is assigned incorrect, then there will be a red box around the terminal button. Reassign the terminal.

Figure 36 Incorrect terminal assignment

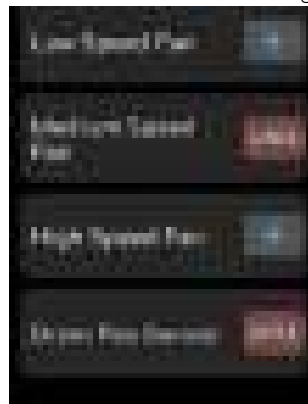

- If the same terminal is assigned to two different functions, the user must resolve the conflict by reassigning the terminal.
- In the below example, user tried to assign UIO1 to Medium speed fan. But the terminal is already assigned to Drain pan sensor. To resolve this issue, tap the Resolve Conflict button. It opens the Drain pan sensor screen. Reassign the terminal for Drain pan sensor



4. Tap the back button after assigning the terminals.
If the user tap the back button without modifying the terminal assignment then the following confirmation message appears.

Figure 37 Discard message

5. Tap **YES** or **DISCARD** as per the requirement.
6. A confirmation message appears, tap **YES** to confirm.

Configuring sensors

Thermostat supports Sylk sensors and Control sensors (temperature and humidity only). In order to ensure proper operation and control, configure for Sylk devices only when using Honeywell compatible sensors.

To configure sensors

1. Swipe left from the Home screen.
2. On the Quick access screen, tap  > **Equipment** > **Sensor Settings**.
The Sensor Settings screen appears.

Figure 38 Sensor settings

3. Tap **Sensors**.
The Sensors screen appears.

Figure 39 Sensors screen



4. Tap the required sensor, relevant sub menu appears to select the settings.

Note: The desired option may be “grayed-out” whenever there are insufficient outputs to support this function. Verify I/O is configured appropriately.

To configure Sylk sensors

Make sure that the required Sylk devices are connected to the thermostat.

1. Swipe left from the Home screen.
2. On the Quick access screen, tap  > **Equipment** > **Sensor Settings** > **Sylk Sensors**.
A list of Sylk devices appear with the respective bus address corresponding to the address number listed in the thermostat listing.

Figure 40 Sylk devices



Note: The total number of Sylk Devices is restricted by Power and Communication bandwidth. In general, the number of Sylk devices cannot exceed the allowed limit. Contact the Honeywell Technical Support team for additional support.

- Tap the right arrow in the menu option to view the dip switch bus address setting guide.

Table 22: Sylk device dip switches

Sylk Address	Device Type	Sensors	DIP Switches
2	Sylk Temperature & Humidity & CO2 sensor	TR40 TR40-H TR40-CO2 TR40-H-CO2	
		TR50-3N TR50-3D	<p>ADDRESS: 1 2 1 2 4 8 16 32 64 128</p> <p>ON / OFF</p> <p>Legend: B=BACnet=Modbus S=SYLK</p>
3	Sylk Temperature sensor	TR40	
4	Sylk Temperature sensor	TR40	
5	Sylk Temperature sensor	TR40	

Note: Set the red colored switches to the position as shown in the above image

Table 22: Sylk device dip switches

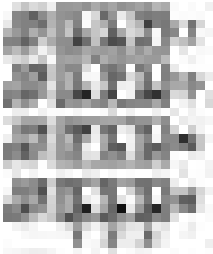
Sylk Address	Device Type	Sensors	DIP Switches
10	Discharge Air Sensor	C7400S	

4. Turn on the sensors.

To configure Sensor offset

1. Swipe left from the Home screen.
2. On the Quick access screen, tap  > **Equipment** > **Sensor Settings** > **Sensor Offset**.
The Sensor Offset screen appears.

Figure 41 Sensor offset

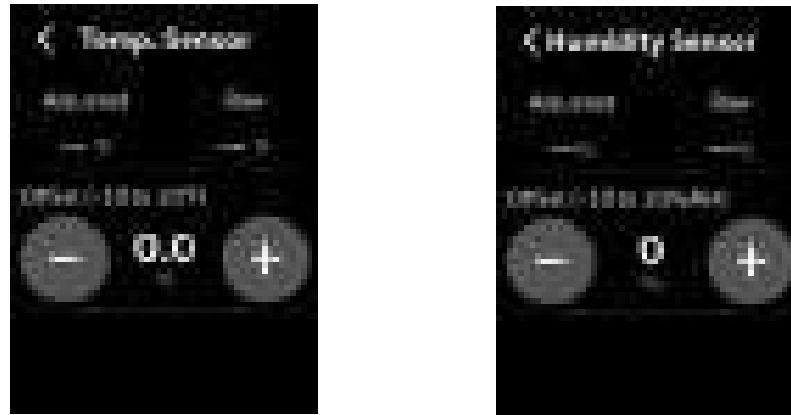

3. Set the offsets for internal temperature sensor and internal humidity sensor.

Figure 42 Offset screens for temperature and humidity

Note: *These offsets should be used only when measured temperature or humidity is verified with calibrated sensor located in same location.*

To configure Control sensors

The thermostat groups the control sensors into three types. There are Local sensor, Remote sensor, and Multi sensor.

Local Sensor: Internal TC300 temperature sensor. Installer can configure offsets to on-board temperature and humidity sensors, if desired.

Remote Sensor: Space temperature sensor connected to UI/UIO terminal, or TR40 sensor configured at address 2.

Multi Sensor: Local Sensor and Sylk sensors at address 2, 3, 4, 5 used together to calculate space temperature.

1. Swipe left from the Home screen.
2. On the Quick access screen, tap  > **Equipment** > **Sensor Settings** > **Control Sensors**.
The Control sensors screen appears. By default, it shows **Local Sensors**. If Remote Sensors are also configured then **Multi-Sensors** and **Remote Sensors** also appear.

Figure 43 Control sensors



Note: If the relevant sensors not available then it will be grayed out.

Managing System switch

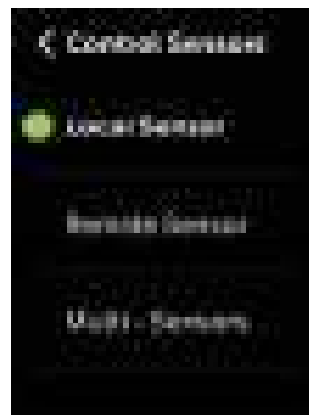
To configure system switch

1. Swipe left from the Home screen.
2. On the Quick access screen, tap  > **Equipment** > **System Switch**.
The System switch screen appears.

Figure 44 System switch

3. Select a system switch that corresponds with the HVAC equipment. Commands from the network to control the system switch mode take precedence over the setting on the TC300. The system switch setting is saved during power outages.

Managing Discharge air control

The discharge air controller option is available only if the selected equipment type is Fan coil with the floating, modulating valve, or 6-way valves.

Enabling Discharge Air Temperature control will result in the thermostat regulating the floating or modulating valves to maintain discharge air temperatures (DAT) within the programmed heating or cooling limits. The discharge air temperature will automatically increase or decrease in proportion to heating or cooling demand.

During active cooling event the DAT will modulate between current cooling minus Cooling Initial Offset (default 0°F/C). Increasing cooling demand will decrease DAT until the minimum DAT setpoint is reached and then fan speed will gradually increase until maximum fan speed is reached. Cooling valves will be regulated to attempt to maintain minimum cooling DAT setpoint.

Sequence for heating is the same as cooling except initial DAT heating setpoint is setpoint plus Heating Initial Offset (default 0°F/C).

To configure Discharge air control

1. Swipe left from the Home screen.

2. On the Quick access screen, tap  > **Equipment** > **Discharge Air Control**.
The Discharge Air Control screen appears.
3. Enable the Discharge Air Control.

Figure 45 Discharge air control



4. Tap **Setpoints** to set the Maximum Heating, Heating Initial Offset, Maximum Cooling, and Cooling Initial Offset.
5. Tap **Heating Gains** to set Throttling Range and Heating Integral Time.
6. Tap **Cooling Gains** to set Throttling Range and Cooling Integral Time.

Figure 46 Discharge air control setpoints

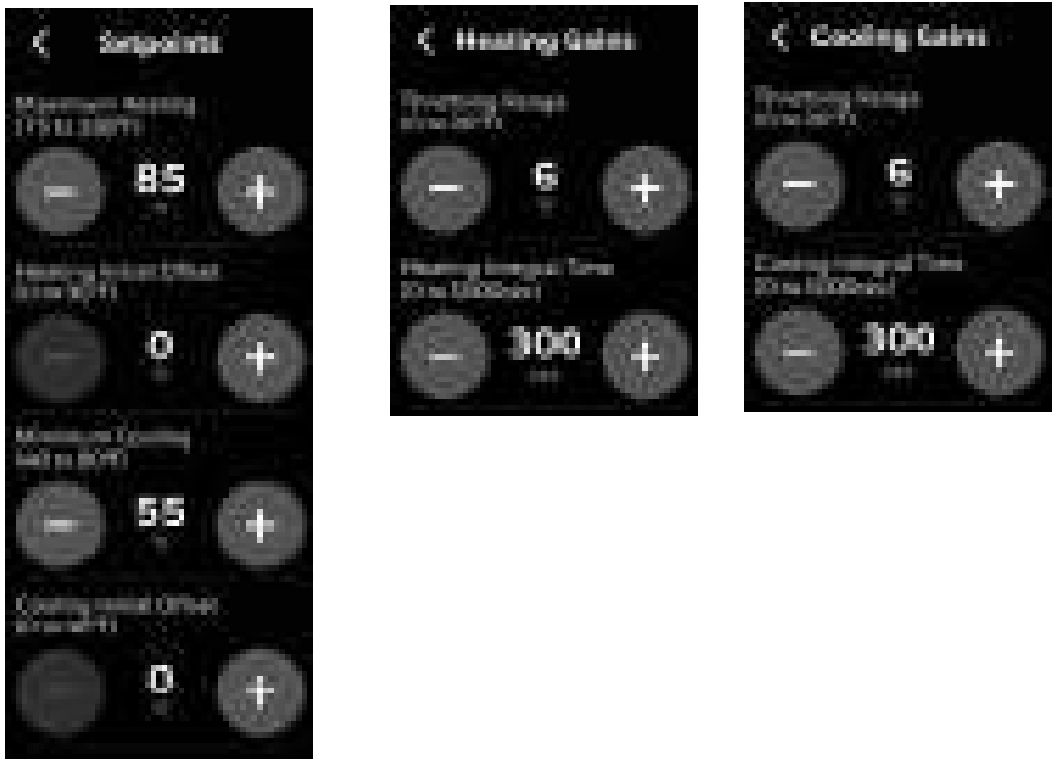

7. Tap the help icon to see the on-screen help.

Figure 47 On-screen help



Managing Dehumidification

Dehumidification function will maintain humidity below programmed setpoint using onboard humidity sensor. For systems without reheat the dehumidification function will allow cooling below the target setpoint based on programmed over cool offset. If humidity threshold cannot be achieved once lower space temperature threshold has been reached the dehumidification function will be suspended. For applications with reheat function setpoint will be maintained during dehumidification cycle by activating reheat using heating coil or via auxiliary heat (electric heat).

To configure dehumidification

1. Swipe left from the Home screen.
2. On the Quick access screen, tap  > **Equipment** > **Dehumidification**.
The Dehumidification screen appears. Enable the dehumidification

Figure 48 Dehumidification



Note: The Reheat option is applicable only for 4-pipe dual coil. Aux Heat for Reheat is applicable for both 4-pipe single coil and 2-pipe single coil.

3. The dehumidification icon appears on Home screen.

Managing Valve cycle

Valve Cycle function is used to periodically cycle valve every 24 hours to minimize risk of sticking/binding.

To configure valve cycle

1. Swipe left from the Home screen.
2. On the Quick access screen, tap  > **Equipment** > **Valve Cycle**.
The Valve Cycle screen appears.

Figure 49 Valve cycle

Advanced configuration

The Advanced configuration screen displays all the advanced options of the thermostat.

To view Advanced options

1. Swipe left from the Home screen.
2. On the Quick access screen, tap  > **Advanced**.
The Advanced configuration screen appears.

Figure 50 Advanced configuration



Managing Setpoint options

This option allows users to set the maximum or minimum temperature setpoints.

To configure setpoint options

1. Swipe left from the Home screen.
2. On the Quick access screen, tap  > **Advanced** > **Setpoint Options**.
The Setpoint options screen appears.

Figure 51 Setpoint options

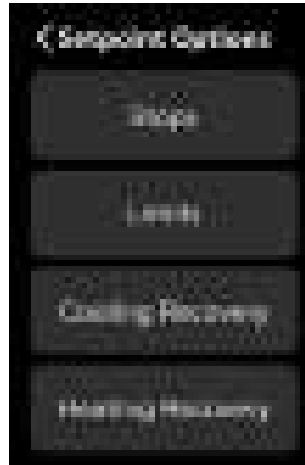

Table 23: Setpoint options

Operation	Configuration Type	Range	Description
Stops	Cooling Min. Setpoint	50-99°F (Default 50°F)	The minimum cool setpoint that can be set by the user
	Heating Max. Setpoint	40-105°F (Default 90°F)	The maximum heat setpoint can be set by the user
Limits	Thermostat Deadband	2°F-8°F(Default: 3°F)	Ensures that the heat setpoint and the cool setpoint maintain a differential minimum temperature span the thermostat is in auto mode.
	Temporary Setpoint Limit	0°F - 45°F (Default 30°F)	The range above or below occupied setpoint by which the temperature may be altered by user from programmed scheduled setpoint in occupied state or when initiating temporary override of schedule. This includes scheduled occupancy or override of the scheduled occupancy (bypass override). During unoccupied and standby periods, the effective setpoint offset is set to 0 Δ°F. If an occupant wants to change the temporary setpoint, the occupant must first override the schedule to occupied and then the thermostat will allow the occupant to change the temporary setpoint

Table 23: Setpoint options

Operation	Configuration Type	Range	Description
Cooling Recovery	Setpoint Ramp	0 -20°F/hr (Default 6°F/hr)	When outside air temperature is available, the effective cool ramp rate is changed as the outdoor air temperature changes. When the outdoor air temperature is at the minimum cool ramp rate temperature (e.g. 90°F) and above, the effective cool ramp rate is at the minimum cool ramp (e.g. 2 Δ°F/hr). When the outdoor air temperature falls, the cool ramp rate is lowered until the maximum cool ramp temperature (e.g. 70°F) is reached or above, the effective cool ramp is at the maximum cool ramp rate (e.g. 6 Δ°F/hr).
Heating Recovery	Setpoint Ramp	0 -36°F/hr (Default 8°F/hr)	When outside air temperature is available, the effective heat ramp rate is changed as the outdoor air temperature changes. When the outdoor air temperature is at the minimum heat ramp rate temperature (e.g. 0°F) and below, the effect heat ramp rate is at the minimum heat ramp (e.g. 2 Δ°F/hr). When the outdoor air temperature is at the maximum heat ramp temperature (e.g. 60°F) and above, the effective heat ramp is at the maximum heat ramp rate (e.g. 8 Δ°F/hr).

Managing Cooling options

To configure cooling options

1. Swipe left from the Home screen.
2. On the Quick access screen, tap  > **Advanced** > **Cooling**.
The Cooling Options screen appears.

Figure 52 Cooling options



Table 24: Cooling options

Cooling type	Configuration Type	Range	Description
DAT Limit	DAT Cooling Low Limit	-40 to 60°F (Default 45°F)	When the discharge air temperature is below the discharge air low limit setpoint, the cooling control will turn off cooling physical output until the discharge air temperature rises above it's setpoint +2 °F differential.
Gains	Throttling Range	0 to 30°F (Default 4°F)	The throttling range is the amount of change in the sensed temperature required to drive the output from 0 to 100%. The throttling range must be narrow enough to provide good control without becoming unstable. The throttling range is determined by factors including: the control application, heating or cooling capacity of the equipment relative to the physical size of the space being controlled, and the control algorithm being used. The narrower (smaller) the throttling range, the more precise the control and the wider (larger) the throttling range, the more stable the control. The objective is setting the throttling range to achieve the optimum balance between precision and stability.
	Cooling Integral Time	0 to 5000 Sec Default 2500 Sec	The amount of time the error has continued uncorrected. Integral action corrects the temperature control errors of proportional-only control, but it is slower to react to large temperature or setpoint changes.
Fan Delay	Fan Off Delay Time	0-180 Sec	Fan run on time after all cooling outputs are turned off. May be used to run fan after all cooling outputs have turned off so that the cooling coil can warm up before the fan turns off to prevent condensation from evaporating into the space.

Managing Heating options

To configure cooling options

1. Swipe left from the Home screen.
2. On the Quick access screen, tap  > **Advanced** > **Heating**.
The Heating Options screen appears.

Figure 53 Heating options



Table 25: Heating options

Heating type	Configuration Type	Range	Description
DAT Limit	DAT Heating High Limit	-60 to 200°F (Default 150°F)	When the discharge air temperature is above the discharge air high limit setpoint, the heating control will turn off heating physical output until the discharge air temperature falls below it's setpoint -2 °F differential. This will help prevent the discharge air temperature from getting too hot and avoid tripping limits.
Gains	Throttling Range	0 to 30°F (Default 4°F)	The throttling range is the amount of change in the sensed temperature required to drive the output from 0 to 100%. The throttling range must be narrow enough to provide good control without becoming unstable. The throttling range is determined by factors including, the control application, the response time of the equipment being controlled, and the control algorithm being used. The narrower (smaller) the throttling range, the more precise the control and the wider (larger) the throttling range, the more stable the control. The objective is setting the throttling range to achieve the optimum balance between precision and stability.
	Heating Integral Time	0 to 5000 Sec Default 2500 Sec	The amount of time the error has continued uncorrected. Integral action corrects the temperature control errors of proportional-only control, but it is slower to react to large temperature or setpoint changes

Table 25: Heating options (Continued)

Heating type	Configuration Type	Range	Description
Fan Delay	Fan On Delay Time	0 to 30 Sec Default 30	Fan on delay time after heating outputs are turned on. May be used to run fan after heating outputs have turned on for some times so that heating coil can warm up.
	Fan Off Delay Time	0 to 180 Sec Default 120 Sec	Fan run on time after all heating outputs are turned off. May be used to run fan after all heating outputs have turned off so that the heat coil can cool down before the fan turns off.

Managing Pipe sensor thresholds

This feature is suitable for heating when pipe temperature is above threshold, and suitable for Cooling when pipe temperature is below threshold.

To configure Pipe sensor thresholds

1. Swipe left from the Home screen.
2. On the Quick access screen, tap  > **Advanced** > **Pipe Sensor Thresholds**.
The Pipe Sensor Thresholds screen appears.

Figure 54 Pipe Sensor Thresholds



Table 26: Pipe sensor threshold

Operation	Configuration Type	Range	Description
Heat/Cool Thresholds (Standard)	Pipe Sensor Threshold for Heating	70 to 90°F (Default 80°F)	When the pipe temperature is above the threshold, it is suitable for heating.
	Pipe Sensor Threshold for Cooling	45 to 65°F (Default 60°F)	When the pipe temperature is below the threshold, it is suitable for cooling.

Table 26: Pipe sensor threshold (Continued)

Operation	Configuration Type	Range	Description
Hybrid Control	Temp Offset (Heat)	5 to 10°F (Default 5°F)	When the pipe temperature is above the space temperature and the hybrid control is enabled, than the offset is suitable for heating.
	Timeout Timer (Heat)	1 to 4 hours (Default 4 hours)	When the configured timer expires, the pipe sensor reading is compared to the threshold setting, if the pipe sensor reading is above the threshold, it will generate water temperature. No heating alarm will be raised.
	Temp Offset (Cool)	-10 to -5°F (Default -5°F)	When the pipe temperature is below the space temperature and the hybrid control is enabled, than the offset is suitable for cooling.
	Timeout Timer (Cool)	1 to 4 hours (Default 4 hours)	When the configured timer expires, the pipe sensor reading is compared to the threshold setting, if the pipe sensor reading is below the threshold, it will generate water temperature. No cooling alarm will be raised.

Managing Valve purge

This setting for 2-pipe systems cycles valve to ensure accurate changeover temperature sensor reading if there are infrequent heating or cooling cycles.

To configure Valve purge

1. Swipe left from the Home screen.
2. On the Quick access screen, tap  > **Advanced** > **Valve Purge**.
The Valve Purge screen appears.

Figure 55 Valve purge



3. Set the purge time and interval.

Miscellaneous

To configure miscellaneous

1. Swipe left from the Home screen.
2. On the Quick access screen, tap  > **Advanced** > **Miscellaneous**.
The Miscellaneous screen appears.

Figure 56 Miscellaneous



3. Power Up Delay Time - The thermostat will perform a delayed after controller power up. User can set 0 to 300 Sec delay. The default is 10 seconds.
4. Force Exit Provisional -

Managing Service mode

Service mode disables all control algorithms to perform service of the equipment. It also provides options to test the terminals for intended output by connecting the test equipment to the terminal and run the algorithm manually.

To enable service mode

1. Swipe left from the Home screen.
2. On the Quick access screen, tap  > **Advanced** > **Service Mode**.
The Service mode YES or NO screen appears, tap YES to enable Service mode.

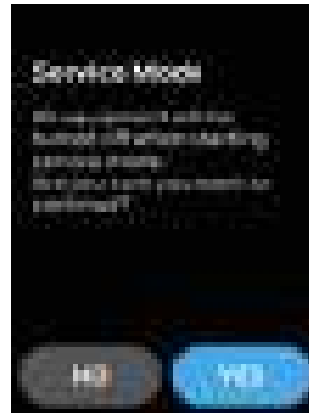
Figure 57 Service mode enabling

Based on terminal configuration, the following screen displays different options for manual testing. For example, in below screen, single speed fan, Heating equipments, Cooling floating, and Aux heat equipments are configured. Connect these test equipment to the relevant terminals and test for actual output.

Figure 58 Service mode

3. Connect the relevant equipment to the terminal and test its functionality.
4. For more examples, in below images, typical options for two speed fan, variable fan, modulating heat, 6-way valve to test its functionality.

Figure 59 Typical service mode options



- To exit the service mode, on the service mode screen, tap the back arrow button. A confirmation message appears.

Figure 60 Service mode exit

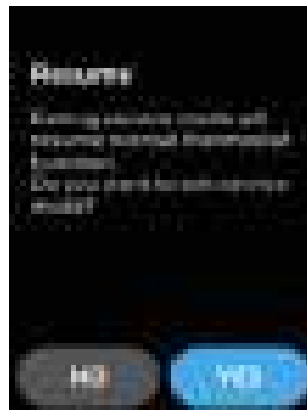

- Tap **YES**.
The service mode will exit and thermostat resume normal function.

Managing Standby action

The Standby Action refers to which mode setpoints to be used while the thermostat is in Standby mode. You can select either Occupied mode or Unoccupied mode.

To set up Standby action

- Swipe left from the Home screen.

2. On the Quick access screen, tap  > **Advanced** > **Standby Action**.
The Standby Action screen appears.

Figure 61 Standby action



3. Tap Treat as Occupied or Treat as Unoccupied.

Viewing the Security log

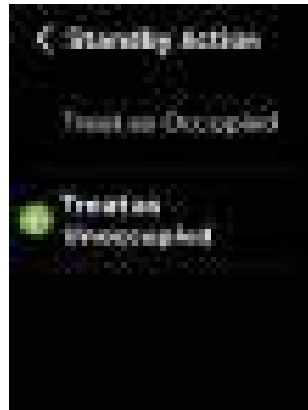
The security log contains records of the critical security events such as password change, user role switch, firmware upgrade and so on.

To view the security log

1. Swipe left from the Home screen.
2. On the Quick access screen, tap  > **Advanced** > **Security Log**.
The Security Log screen appears.

Figure 62 Security log



Viewing the Diagnostics

The diagnostics information of the thermostat helps to service the device based on the log information.

To view the Diagnostics

1. Swipe left from the Home screen.
2. On the Quick access screen, tap  > **Advanced** > **Diagnostics**.
The Diagnostics screen appears.

Figure 63 Diagnostics

3. Log info - Log info of thermostat like device restart and other exception issues.
4. Memory Usage - Memory usage of the firmware.
5. Application Info - Application info shows DDC runtime.
6. Thermal Info - Thermal information of the connected devices.

Managing connection

TC300 supports BACnet MS/TP connection and Modbus connection. Either BACnet MS/TP or Modbus connection can be enabled at a time.

To connect thermostat via BACnet MS/TP

1. Swipe left from the Home screen.
2. On the Quick access screen, tap  > **Connection**.
The Connection screen appears.

Figure 64 BACnet MS/TP connection

3. Tap the **BACnet MS/TP**.
The BACnet MS/TP screen appears.

Figure 65 BACnet MS/TP

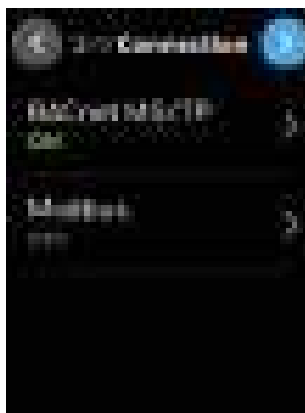

4. Tap **BACnet MS/TP** and enable it.
The BACnet MS/TP range screen appears.

Figure 66 BACnet MS/TP



5. The device automatically adapts to the baud rate of the MS/TP network. You can also manually select the Baudrate
6. Enter a unique Device ID for the thermostat. It should be different from other TC300 thermostats.
7. Auto-MAC addressing is enabled by default, Installer can also manually set a unique MAC address for the TC300.

Note: *The baud rate can be manually configured only after initial 5 minute delay.*

8. To do manual configuration, tap **Manual**.
A text box appears below to enter the manual MAC address.
9. Tap **Baud Rate**, to select a desired baud rate from the list.

Figure 67 Baud Rate



10. Tap the back arrow button to navigate back to BACnet MS/TP setting screen.

11. Tap **BACnet MS/TP Setting**.

The BACnet MS/TP setting screen appears.

Figure 68 BACnet MS/TP Setting



12. Set the desired parameters and tap the back arrow button to navigate back to the connection screen.

TC300 will try to adapt to the Baudrate of the MS/TP network in the first 4 minutes after startup or MS/TP is enabled. If no Baudrate could be determined, for example, there is a single device on the network, then TC300 will choose the default Baudrate of 76800. After that, the Installer can manually change it to another value.

To connect thermostat via Modbus

1. On the Connection screen, tap **Modbus** and enable it. The Modbus setting screen appears.

Figure 69 Modbus



2. Enter a unique address for the thermostat. It should be different from other TC300 thermostats.
3. Set the Baud Rate, Stopbits, and Parity from the list.
4. Tap the back arrow button to navigate back to the connection screen.

User management

The TC300 supports four kinds of user identities as identified in Table 27 with limited privileges as noted. Except for the Installer role these privileges can be reduced in the user settings menu.

Table 27: User roles and permissions

	Visitor	Basic User	Admin	Installer
System Mode		✓	✓	✓
Override		✓	✓	✓
View Alarm		✓	✓	✓
Temperature Units		✓	✓	✓
Fan Speed Configuration		✓	✓	✓
Brightness		✓	✓	✓
Schedule			✓	✓
Setpoint			✓	✓
Basic Configuration			✓	✓
System Mode		✓	✓	✓
Advanced Configuration				✓

Passcode rules

All the user accounts are passcode protected. When creating the passcode, follow the passcode rules given below.

- Passcode length must be between 4 to 12 characters
- Do not use spaces
- Do not use the same passcode used for other users (across all user types)
- If no passcode is entered for basic or Admin, the thermostat will remain at the highest level of access, installer, and will not require a passcode for access.

Configuring the user roles

To configure user management



1. Swipe left from the Home screen.
2. On the Quick access screen, tap  > **User Management**.
The User Management screen appears.

Figure 70 User management



Visitor

To view the Visitor user role

1. On the User Management screen, select **Visitor**.
2. Tap  to go to the previous screen.

Basic user

To manage the Basic User role

1. On the User Management screen, select **Basic User**, and tap . The Basic User screen appears.
2. Set a passcode and user permission. The passcode will be used by the user to access the thermostat. Refer to [Passcode rules](#).

Note: The Passcode button appears only if the pass is set for the Basic user.

Figure 71 Basic user

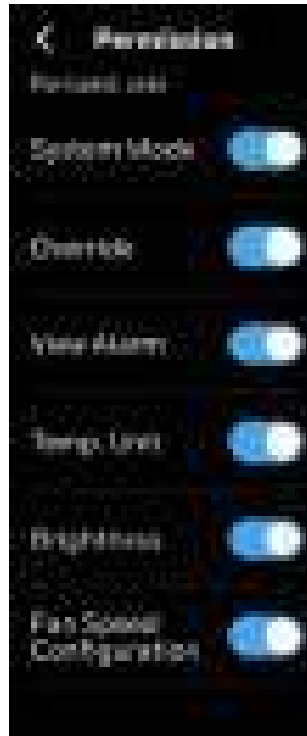

3. Tap **Permission**. The Permission screen appears.

Figure 72 Basic user permission.

4. Toggle the undesired Permissions to “Off” position.

Admin

To manage the Admin role

1. On the User Management screen, select **Admin**, and tap . The Admin User screen appears.
2. Set a passcode and user permission. The passcode will be used by the Admin user to access the thermostat. Refer to [Passcode rules](#).

Figure 73 Admin user

3. Tap **Permission**. The Permission screen appears.

Figure 74 Admin user permission.

4. Toggle the undesired Permissions to “Off” position.

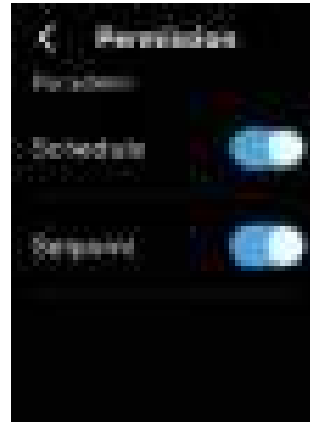
Installer

To manage the Installer role

1. On the User Management screen, select **Installer**, and tap .
2. Set or change a Passcode. Refer to [Passcode rules](#).

Figure 75 Installer

Configuring Home screen (Display Management)

This section explains managing the icons displayed on the Home screen and Ambiance screen of thermostat. It is applicable at the device level so any changes on the display management will be applied to all user accounts.

To configure the home screen

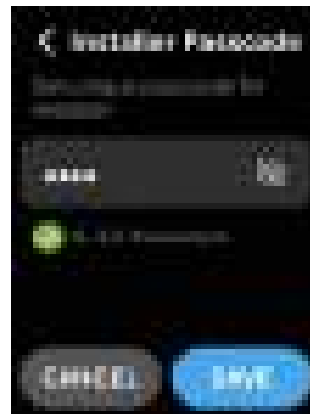
1. Swipe left from the Home screen.
2. On the Quick access screen, tap  > **Display Management**.
The Display Management screen appears.

Figure 76 Display management



All icons are enabled by default. You can turn it off by sliding the toggle button to the left.

3. Tap **Branding** to select a brand name that will be displayed on the home screen.
4. Scroll down to see more options.

Note: Tap the information icon to view the icon names.

Managing display settings

Display settings of the thermostat includes increasing/reducing display brightness and settings to off the display, dim the display, or show only ring when the display is on sleep mode.

To manage display settings

1. Swipe left from the Home screen.

Figure 77 Quick access screen

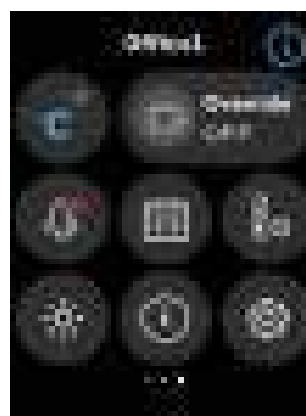

- On the Quick access screen, tap . The Display Settings screen appears.

Figure 78 Display settings



- Tap **Brightness**. The Brightness screen appears.

Figure 79 Brightness

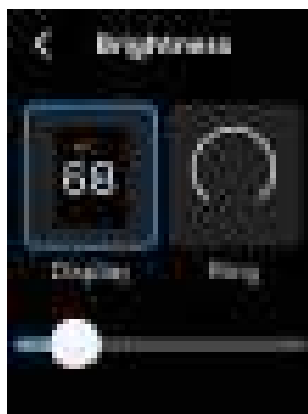

- Tap Display and move the slider to right to increase the brightness of the display.
- Tap Ring and move the slider to the right to increase the brightness of the ring.
- Navigate back to the Display settings screen to configure Inactive display.
- Tap **Inactive Display**. The Inactive Display screen appears. The inactive display is when there is no user action on the display. User either can set the display always on or always off.

Figure 80 Inactive display

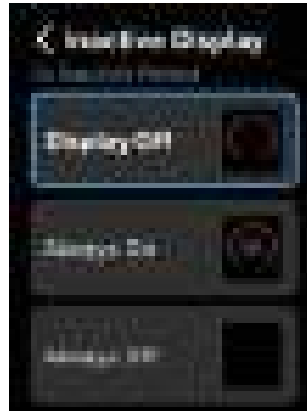

8. Tap **Display Off** to set the display off. However, the ring LED breaths to show the system mode. Or, tap **Always On** to show both display and ring LED. Or, tap **Always Off** to keep both ring LED and display off.

Reset to default

User can reset the entire thermostat to the factory default or reset only temperature setpoints and schedule to factory default.

To reset the factory default setting

1. Swipe left from the Home screen.
2. On the Quick access screen, tap  > **Reset to default**.
The Reset to Default screen appears.

Figure 81 Reset to default



3. Tap **Reset Weekly Schedule & Setpoint** to only reset the temperature and schedule setpoint. It retains other configurations.
4. Tap **Reset All** to fully reset the thermostat. It deletes all the configurations and user data.
5. Tap **Restart Device** to restart the device without deleting any data.

Figure 82 Weekly reset and confirmation message

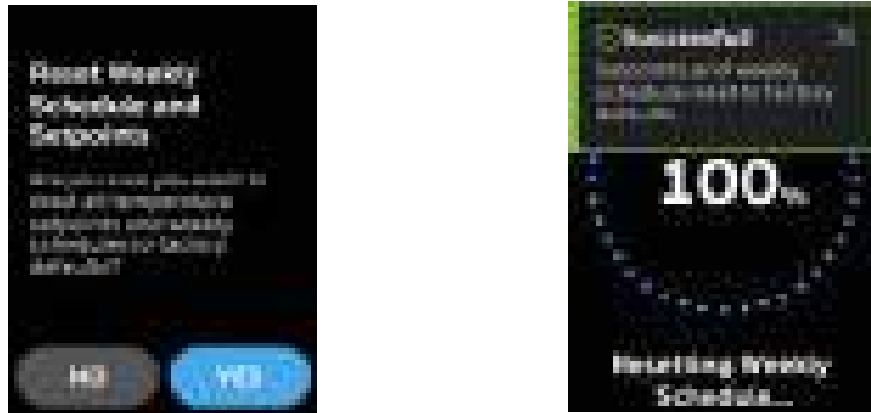

6. Upon successful reset, user will be notified by a notification banner.

Viewing the system status

The system status shows device information, live status and readings of the sensors that are operated or connected with the thermostat. These values are view only.

To view system status

1. Swipe left from the Home screen.

Figure 83 Quick access screen

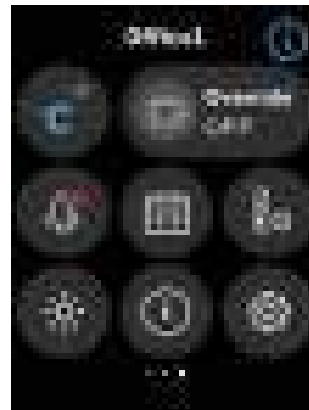

2. On the Quick access screen, tap . The System status screen appears.

Figure 84 System status**Table 28: System status**

Operating status	Equipment type, Current operating mode, Heat status, Cool status, Aux heat, Fan status, Indoor temperature, Indoor setpoint, Indoor humidity, Indoor CO2, Discharge air temperature, Discharge air control setpoint, Pipe temperature, Recovery status, Override remaining, Run time, Restart reason, Terminal load, UTC offset
Schedule	Current schedule time, Current occupancy state, Current schedule state, Next schedule state, Time to next schedule state,
Configurable I/O	All terminals ON/OFF status.
Device	Model name, Boot loader version, Firmware version, Application version, UUID, Serial No.
Network status	For BACnet MS/TP: Device ID, MAC address, Baud rate. For Modbus: Address, Baud rate, Parity, Stopbits
Service	Service personnel name and phone number.

Managing Setpoints

To configure setpoint settings

1. Swipe left from the Home screen.

Figure 85 Quick access screen

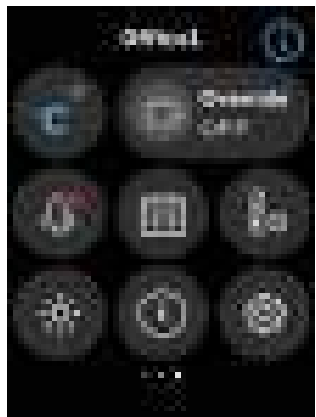

- 2. On the Quick access screen, tap . The Setpoint screen appears.

Figure 86 Define the setpoints



- 3. On the **Setpoint** screen, tap **Occupied**, **Standby**, or **Unoccupied**. The Occupied screen appears.

Figure 87 Occupied

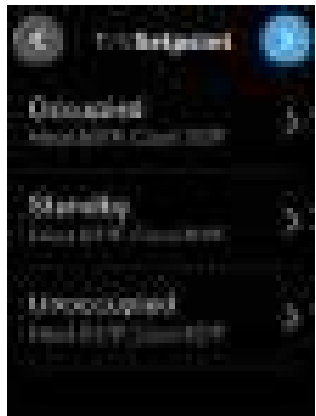
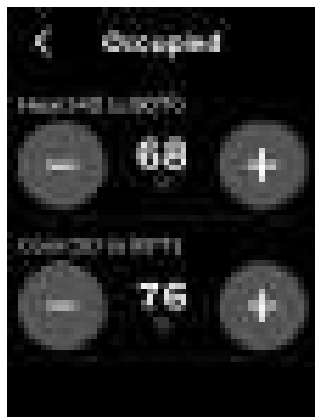

Tip: Long press the +/- button to quickly increase or decrease the value.

4. Configure the required setpoint limits for Occupied, Standby, and Unoccupied modes. Thermostat performs limit checking on all temperature setpoints, in case setpoint relationships are violated.
 - Occupied mode treats the building space as occupied and configured with comfort setpoints.
 - Unoccupied mode treats the building space as not occupied and configured with energy savings setpoints.
 - Standby mode setpoints are configured in a way that target setpoint levels can be achieved quickly with the onset of the next occupied period.
 - Temporary mode allows the user to change the temperature setpoints of the Occupied mode after the user switches to the temporary mode from the Occupied mode. This is not possible in Unoccupied mode and Standby mode.
 - Minimum cool setpoint and maximum heat setpoint can be adjusted, default minimum cool setpoint is 50°F, maximum heat setpoint is 90°F. Heat setpoint range: 40°F-90°F; Cool setpoint range: 50°F-99°F.
 - While configuring the temperature range make sure that the unoccupied heat \leq standby heat \leq occupied heat $<$ occupied cool \leq standby cool \leq unoccupied cool.
 - Occupied cool setpoint should be at least a deadband value bigger than occupied heat setpoint.

Occupancy sensor behavior

- The occupancy sensor only affects the effective occupancy when the scheduled occupancy state is Occupied:
- When occupancy sensor state is occupied, the effective occupancy will act as occupied.
- When occupancy sensor state is unoccupied, the effective occupancy will change to standby.
- When the scheduled occupancy state is unoccupied or standby, the effective occupancy will follow scheduled occupancy state, will ignore the occupancy sensor's value.

Changing the system mode

To change the system mode

1. On the Home screen, tap mode icon, for example  The Mode screen appears.

Figure 88 System mode



2. Select a mode and tap the back arrow button. The mode is changed.

Changing the fan speed

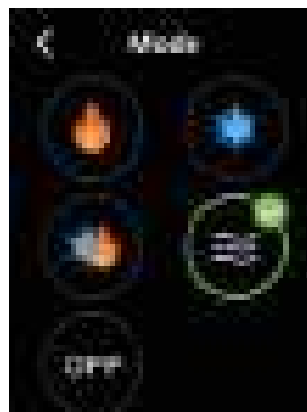
To change the fan speed

1. On the Home screen, tap mode icon, for example  The Fan Speed screen appears.

Figure 89 Fan speed



2. Select a fan speed and tap the back arrow button. The fan speed is changed. Auto fan can be selected only during Standby or Unoccupied status. During dehumidification, the fan speed will be limited to low speed automatically.
3. Tap the help icon to view the fan mode description.

Figure 90 Fan speed help

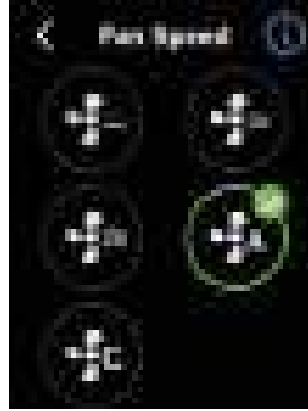
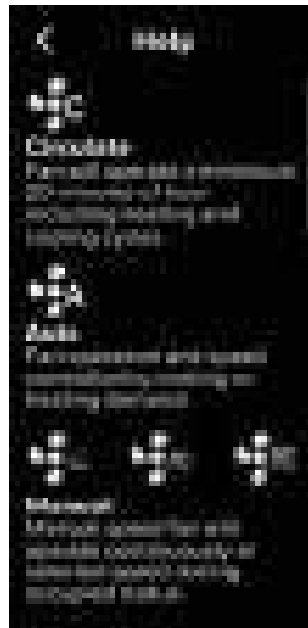

This chapter explains alarms and their configuration procedures.

Related topics[Alarms](#)[Alarm notification signs](#)[Alarm notification](#)[Alarm preference](#)[Unacknowledged alarms](#)[List of alarms and their severity](#)[Managing the alarms](#)

Alarms

In the TC300 thermostat, alarms are configured for predefined set values. When the values are breached, the alarms are triggered and displayed on the home screen as banner notification, dot notification, and on the Alarm button. You can view the triggered alarms and acknowledge them.

Alarm notification signs

The alarm menu notification icon has two color codes to indicate the severity of the alarm. The following table describes the available signs with color codes of the alarm screens.

Icons	Description
	High
	Medium

Alarm notification

The alarms can be configured as banner notification or dot notification as per the alarm configuration. The banner notification is pop-up on the home screen whereas the dot notification appears beside the time. For alarm configuration, refer to [Configuring the alarm preference](#).

Figure 91 Alarm banner notification



You can tap the banner notification to view the alarm and acknowledge it. If multiple alarms are triggered then the latest one (high) will be displayed on the home screen. After tapping the banner, it takes you to the **Alarm** screen.

- High - Red color banner
- Medium - Orange color banner

Alarm preference

To create alarm preference

1. Swipe left from the Home screen.
2. On the Quick access screen, tap  > **Alarm Preference**.
The Alarm preference screen appears.

Figure 92 Alarm preference



3. Tap **Alarm**.
A list of alarm types appears.

Figure 93 Alarm types



4. Tap an alarm type, for example, Proof of air flow alarm. The configuration screen of the alarm type appears.

Figure 94 Alarm configuration screen

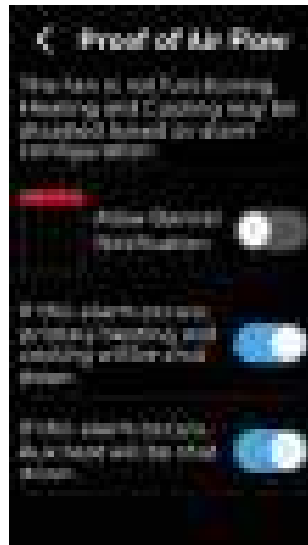

Alarm reason description is displayed on the screen.

5. Toggle the **Allow Banner Notification** to on to get the banner notification of the this type of alarm on the home screen.

Note: *Dot notification of alarm is default. The dot will appear on Alarm bell icon on the home screen and Configuration screen.*

6. Toggle the follow up actions such primary heating and cooling shutdown, and Aux heat shutdown for this alarm if required.

To configure alarm limits

1. On the **Alarm Preference** screen, tap **Alarm Limits**.
The Alarm Limits screen appears.

Figure 95 Alarm limits



2. Tap **Space Temperature Limits** to set the limits for space temperature, when its break, alarm will be raised.
3. Tap **Discharge Temperature Limits** to set the limits for DAT, when its break, alarm will be raised.

4. Tap **Pipe Temperature Limits** to set the limits for pipe temperature, when its break, alarm will be raised.

Figure 96 Alarm limits



Unacknowledged alarms

In addition to the banner notification, all other alarms (for which the notification is not configured) can be viewed and acknowledged under the Alarm screen. The Alarm tab displays the alarms that have not been acknowledged by the user. If there are unacknowledged alarms, the Alarm button will have a visual dot notification as per the severity of the alarm.

To view the unacknowledged alarms

1. Swipe left from the Home screen.
2. On the Quick access screen, tap the bell (Alarm) icon.

Figure 97 Home screen - Alarm Tab

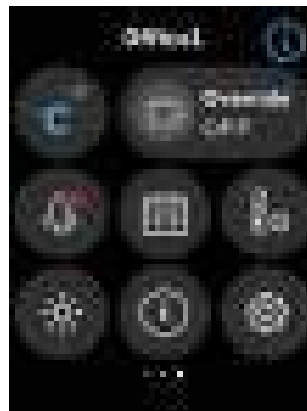

The Alarm Preference screen appears.

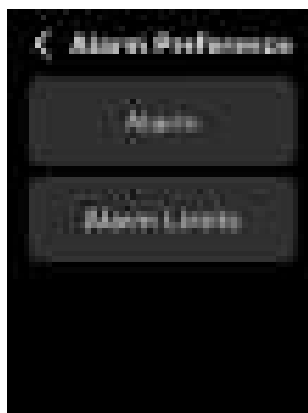
Figure 98 Alarm preference - Alarm

3. Tap **Alarm**.
A list of unacknowledged alarms appears.

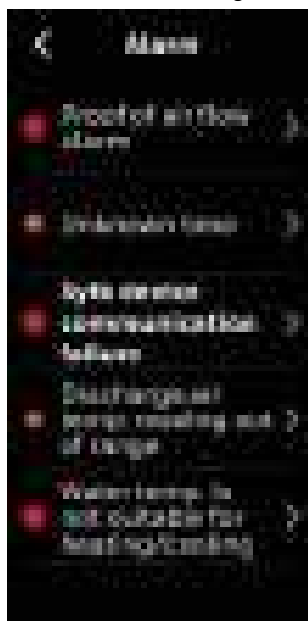
Figure 99 Unacknowledged alarms

4. Tap an Alarm name.
The corresponding alarm property screen appears. The alarm property screen describes the nature of event state transition.

Figure 100 Alarm detail



5. Tap **CONFIRM**.
The Alarm Detail screen appears.

Figure 101 Alarm detail

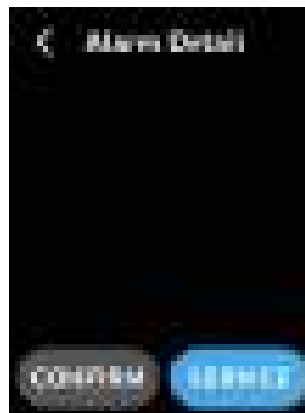

6. Tap **SERVICE** to see the service phone number.

List of alarms and their severity

The list of alarms in the Commercial Connected thermostat is as follows

Alarms	Severity
Proof of Air Flow Alarm	High
Space Freeze Protection Alarm	High
Space Temperature Sensor Failure	High/Medium
Space Temperature Out of Range	High/Medium
Space Humidity Sensor Failure	High/Medium
Discharge Air Temp. Sensor Failure	High
Discharge Air Temperature out of range alarm	Medium
Drain Pan Sensor Alarm	High
Sylk Device Communication Failure	High
Pipe Sensor Failure	High

Alarms	Severity
Pipe Sensor Out of Range	High
Water Temperature is Not Suitable for Heating/Cooling	High
Room Temperature Changing Trend is Reversed with System Mode	High
Unknown Time	Medium

Managing the alarms

S.NO	Alarm	Trigger Scenario	Action	Level
1	Proof of Air Flow Alarm (fan state)	An input (e.g., a current switch or differential pressure switch) should be available to monitor proof of air flow in the Fan Coil Unit. When configured, the control system will check this digital input once per second. If the fan is supposed to be on but is not, an alarm should be generated. For example, users can configure a DIO/UIO terminal as a binary input to detect the fan's status. When DIO2 is set as the Fan Command, and the device sets DIO2 to 'on,' if the digital input indicates no air flow for 60 consecutive seconds, a 'Proof of Air Flow' alarm will be triggered.	Depending on the alarm configuration: 1. Display Only: An alarm will be generated, and an alarm indicator will be displayed. 2. The control system will shut down both heating and cooling outputs. The fan speed will follow the fan control logic. (1) The fan will remain on if there is still a call for heating or cooling. (2) In other scenarios where the fan should be on, the fan will operate based on the scheduled status: when the fan speed is set to low/medium/high, it will be on if the schedule status is 'occupied,' 'temporary,' or 'permanent.' If the fan speed is set to 'circulate,' the fan will run for at least 20 minutes per hour. 3. Upon Alarm: Dehumidification will be disabled. Both cooling and heating outputs, as well as the fan, will be turned off.	High
2	Space Freeze Protection Alarm	When the space temperature falls below 42.8°F (6°C) for more than 2 minutes, a frost alarm will be triggered. If the controller is disabled, in test mode, or in any other higher-priority mode defined by the application, the frost alarm will not be activated.	1. If the system mode is set to OFF, the freeze protection feature will activate, utilizing the effective heating setpoint, until the room temperature reaches either the heating setpoint or 8°C (46°F). 2. If the system mode isn't set to OFF, it will operate based on the standard control logic.	High
3	Sylk Device Communication Failure	If any of the Sylk sensors experience a malfunction, an alarm will be activated. This alarm will provide detailed failure information sourced from Sylk, e.g., addr10: DAT sensor malfunction.	In case a sensor malfunctions, the thermostat will deactivate all control functions linked with that sensor, behaving as if that sensor had never been set up.	High
4	Discharge Air Temperature sensor failure	1. DAT sensor fault: Open/short limit is detected on Discharge air sensor(DIO1/DIO2/UIO1/UIO2) 2. DAT reading outside of the following range (Range can be set on the Alarm Limits screen): High Limit: default 80°F,70°F to 180°F Low Limit: default 45°F,35°F to 65°F	1. DAT sensor fault: The thermostat will deactivate all control functions related to the failed sensor, meaning it will function as though the sensor wasn't configured. 2. DAT out of range: The thermostat will not deactivate the control function. The user need to check the equipment for correct operation.	High (failure)/ Medium (out of range)

S.NO	Alarm	Trigger Scenario	Action	Level
5	Space Temperature Sensor Failure	<ol style="list-style-type: none"> 1. Local Space temp as the main control and sensor fault is detected. 2. Remote Space temp as the main control. sensor fault is detected. 3. Multi space temp as the main control. All/Some of the temp sources have sensor fault detected. 4. There is a network input space temperature, and the network input space temperature value is below -40°F or above 150°F. 	<ol style="list-style-type: none"> 1. If the sensor is utilized for the control loop and network input of temperature is available, the thermostat will only trigger an alarm. 2. If the sensor is used for the control loop and the network input of temperature/humidity is not available, the thermostat will turn off all output controls for the Heating and Cooling equipment. The fan will continue to operate normally. 	High (Action 2)/ Medium (Action 1)
5	Space Temperature out of range alarm	The space temperature has exceeded the defined range (you can set this range on the alarm limits screen). This applies to whichever sensor is acting as the space temperature sensor, including network inputs.	The thermostat will only trigger an alarm.	Medium
6	Space Humidity Sensor Failure	<ol style="list-style-type: none"> 1. The Local Space Humidity sensor is used as the primary data source for control, and a fault has been detected in this sensor. 2. The Remote Space Humidity sensor is used as the primary data source for control, and a fault has been detected in this sensor. 3. Multiple Space Humidity sensors are used as the primary data sources for control, and faults have been detected in one or more of these sensors. 	<ol style="list-style-type: none"> 1. If the sensor is utilized for control loops and network input for temperature/humidity is available, the thermostat will only trigger an alarm. 2. If network input for temperature/humidity is not available, the thermostat will disable all control functions (e.g., humidity control for humidification or dehumidification) related to the malfunctioning sensor. 	High(Action 2)/ Medium(Action 1)
7	Unknown Time	The thermostat has been disconnected from power for an extended period, causing the real-time clock (RTC) to reset.	Ask the user to update the date and time.	Medium
8	Drain pan sensor alarm	The user can set up the DIO/UIO terminal as a binary input to monitor water leakage. Upon activation of this input, a drain pan alarm will be initiated.	User can configure the operation would be taken when drain pan alarm is detected: 1, disable cooling. 2, disable heating. 3, disable fan	High
9	Pipe sensor failure	Should a fault be detected with the pipe sensor, or if the temperature of the pipe falls outside the specified range, the system will respond accordingly. Configurable range settings can be adjusted in the 'Alarm Limits' section. High Limit: Default at 180°F (range: 70°F to 220°F). Low Limit: Default at 40°F (range: 30°F to 60°F).	Both heating and cooling functions will be deactivated.	High

S.NO	Alarm	Trigger Scenario	Action	Level
10	Water temperature is not suitable for Heating/Cooling	<p>Applicable only for Dual-Pipe FCU Heating/Cooling Systems.</p> <ol style="list-style-type: none"> Based on the Pipe Sensor transition mode: <ol style="list-style-type: none"> If Hybrid Control is set to Off: For heating, if the Pipe Sensor reading is below the Pipe Sensor Threshold for Heating, or for cooling, if the Pipe Sensor reading is above the Pipe Sensor Threshold for Cooling. If Hybrid Control is set to On: For either heating or cooling, even though the Pipe Sensor reading might be below or above the corresponding Threshold, if it's within 5°F (Temp Offset, configurable) of the space temperature, no alarm is triggered. However, if it remains below or above the respective Threshold for 4 hours (Timeout Timer, configurable), an alarm is triggered. Based on Network Input Changeover Mode: If 'ni_pipetempmode' is opposite to the current heating or cooling mode or is set to 'no use'. Based on Changeover Switch Mode: If the switch is set to heating while the current mode is cooling, or if the switch is set to cooling while the current mode is heating. 	The heating/cooling valve will be closed, and the fan will run based on the fan speed configuration. While the alarm exists, use a purge interval of 0.5 to perform a pipe purge.	High
11	Room temperature changing trend is reversed with system mode	<ol style="list-style-type: none"> If heating is enabled, but there's a drop of $\geq 1^{\circ}\text{F}$ within 30 minutes, an alarm will be triggered. If cooling is enabled, but there's an increase of $\geq 1^{\circ}\text{F}$ within 30 minutes, an alarm will be triggered. 	<p>Depend on the alarm configuration:</p> <ol style="list-style-type: none"> If the toggle button is turned off, only the alarm will be reported. If the toggle button is turned on, both heating and cooling will be deactivated. 	High

About Schedule

TC300 enables you to plan operations based on the time of day and holidays.

This scheduling structure allows you to control day-to-day operations with the standard schedule. The holiday schedule controls days or times when a facility is typically unoccupied. The event schedule controls periods outside normal occupied times. The holiday schedule overrides the standard schedule and the event schedule overrides the holiday and standard schedules within a schedule set.

Schedules use the setpoint configuration of Occupied, Unoccupied, or Standby modes.

Occupied mode treats the building space as occupied and configured with comfort setpoints.

Unoccupied mode treats the building space as not occupied and configured with energy savings setpoints.

Standby mode setpoints are configured in a way that the setpoints can quickly change to the Occupied mode when switched. Standby mode setpoint saves energy higher than occupied mode and lesser than the Unoccupied mode.

Temporary mode allows the user to change the temperature setpoints of the Occupied mode after the user switches to the temporary mode from the Occupied mode. This is not possible in Unoccupied mode and Standby mode.

When a schedule uses the Occupied mode but the Occupancy sensor reads unoccupied, then the thermostat switches automatically to the Standby mode. In other scenarios, the thermostat follows the schedule status and the occupancy sensor's value has no impact on it.

How schedules works

When you set up schedules, it is important to understand the relationship of the schedules in the schedule set and how to use each one.

- **Standard schedule:** Use the weekly schedule to program occupied and standby periods for each of the week.
- **Holiday schedule:** Use holiday schedules to set holidays that “float” or occur on a specific date each year. Up to 10 holidays can be created.

- **Special event:** Use Special event to create up to 10 special events.

Note: *Holiday schedules automatically write a 12:00 AM OFF time, which is in effect unless it is overridden by an event schedule.*

Related topics

[Setting up a weekly schedule](#)

[Setting up a holiday schedule](#)

[Special event](#)

Setting up a weekly schedule

To add a new time value to a weekly schedule

1. Swipe left from the Home screen.
The Quick access screen appears.

Figure 102 Quick access screen

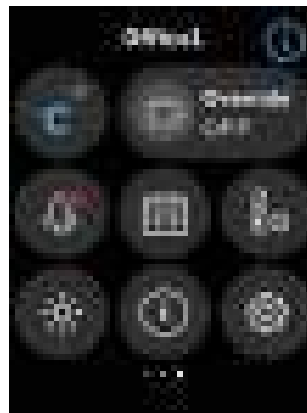

2. On the Quick access screen, tap  **Schedule**.
The schedule main screen appears which lists all types of schedules available in the thermostat.

Figure 103 Schedule types



3. Tap **Weekly** to add a new schedule.
The Weekly screen appears.

Figure 104 Weekly schedule screen

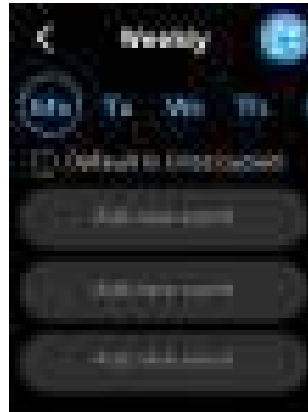

4. Select a day when to apply the weekly schedule.
5. Tap **Add new event**
The Create screen appears.
It displays two event types for scheduling. Occupied and Standby.

Figure 105 Weekly event screen



6. Tap the information icon to read the schedule events limits.

Figure 106 Weekly Schedule help information

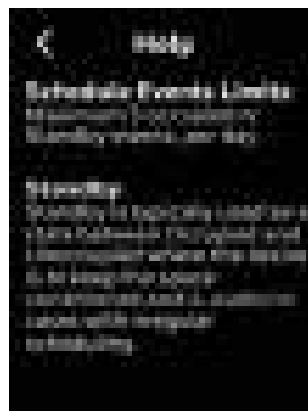

7. Set the start and end time for the event.

8. Tap an event type (Occupied or Standby).

9. Tap **SAVE**.

The Weekly screen appears. It displays the created schedule under Monday. You can copy the schedule to other days. Refer to [Copying the schedules from one day to another](#).

Figure 107 Weekly schedule.

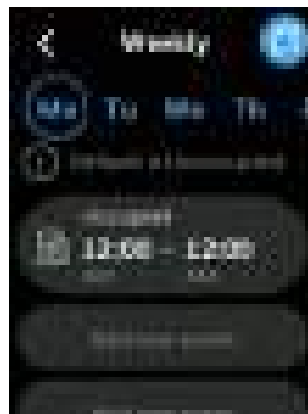

Note: *Scroll horizontally to view the entire screen.*

10. To add another schedule, tap **Add new event**.

11. Tap the back button to exit the scheduling.

Note: *System would be unoccupied automatically outside the scheduled time slot.*

Editing or deleting weekly schedules

The existing weekly schedules can be edited from the Weekly schedule screen.

To change or delete an existing weekly schedule

1. On the **Weekly schedule** screen, tap the schedule to be modified.
The Edit screen will appear.

Figure 108 Editing a regular schedule

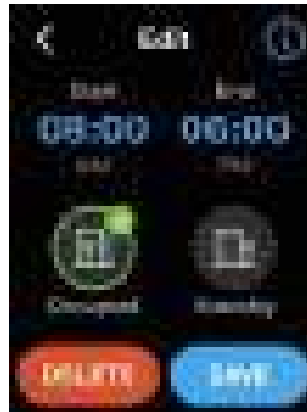

2. Select the new Start and End time and mode.
3. Tap **SAVE** to save changes or Tap **DELETE** to delete the schedule.

Copying the schedules from one day to another

The TC300 enables the user to copy an existing regular schedule.

To copy a schedule from one day to another

1. Navigate to the Weekly schedule screen from where the schedule is to be copied. Select a day to copy.
2. Tap  to copy schedules from Monday. Copy screen will appear.

Figure 109 Copy Schedule



3. Tap on the days of the week for which schedule is to be copied.

Figure 110 Select Days

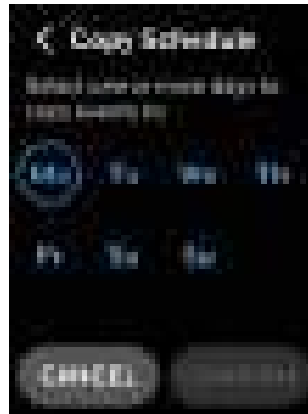
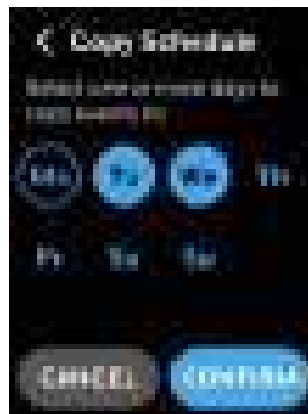

4. Tap **CONFIRM**.
Schedule copied successful confirmation message appears.

Figure 111 Copy successful

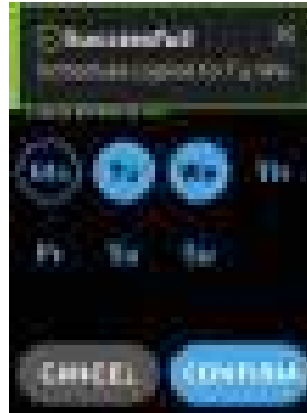

Setting up a holiday schedule

Holidays are defined as reoccurring events that are different from the weekly schedule, can be Occupied or Standby, or by default Unoccupied. So the Unoccupied/Standby mode setpoints will be executed on the holidays. There are two holiday types available to choose. There are **Floating date** and **Specific date**. Only one day can be selected for the floating holiday type whereas multiple days can be selected for Specific date type.

To schedule a holiday

1. Swipe left from the Home screen.
The Quick access screen appears.

Figure 112 Quick access screen

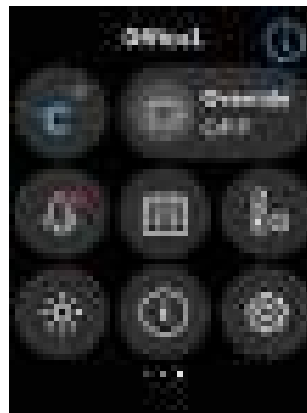

2. On the Quick access screen, tap  **Schedule**.

Figure 113 Schedule types



3. Tap **Holiday** to add a new holiday schedule.
The Holiday screen appears.

Figure 114 Holiday screen



4. Tap the add button to add a Holiday.
The Create Holiday screen appears.

Figure 115 Creating Holiday



5. Tap **Date**.
The Set Date screen appears.

Figure 116 Set Date



6. Tap **Floating Date** to schedule a floating date as a holiday (Organization related holidays) or tap Specific Date to schedule festival holidays, government holidays, or public holidays.
If Floating date is selected, then you can choose only one day to create an event.
7. Tap the clock icon.
8. Select a date.
9. Tap **CONFIRM**.
The Set Date screen appears. If you are configuring a Specific Date holiday type, then you can add multiple days by tapping the **How is the holiday** with first date is fixed date.
10. Tap **Save**.
The Create Holiday screen appears.
11. Tap **Event** to configure the actions to be executed on the configured holiday (s).
12. Tap **Set Event**.
Event list screen for the set date appears. You can add a maximum of four events.

Figure 117 Date screen for special events

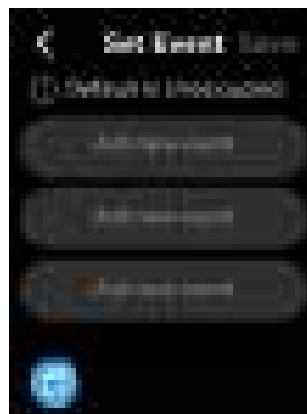

13. Tap **Add new event**.
The Create screen appears.

Figure 118 Create holiday vent screen

14. Tap the Start clock icon to set the event start time.
15. Set the start time and then tap **CONFIRM**.
16. Tap the End clock icon.
17. Set the event end time and then tap **CONFIRM**.
18. Tap **Occupied** or **Standby** based on your requirement.
19. Tap **SAVE**.
The created event appears on the Holiday screen.
20. Tap **SAVE**.
21. Tap **Done**.
The holiday creation successful message appears.

Editing or deleting Holiday

The existing weekly Holidays can be edited from the Holiday screen.

To change or delete an existing holiday

1. On the **Holiday** screen, tap the schedule to be modified.
The Edit screen will appear.

Figure 119 Editing a regular Holiday

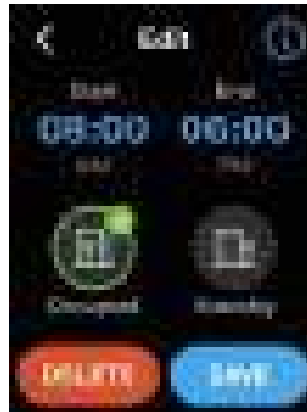

2. Select the new Start and End time and mode.
3. Tap **SAVE** to save changes or Tap **DELETE** to delete the schedule.

Copying the Holiday events from one day to another

The TC300 enables the user to copy an existing holidays.

To copy a schedule from one day to another

1. Navigate to the Holiday screen from where the holiday is to be copied.
Select a day to copy.
2. Tap  to copy holiday from Monday.
Copy screen will appear.

Figure 120 Copy holiday



3. Tap on the days of the week for which schedule is to be copied.

Figure 121 Select Days

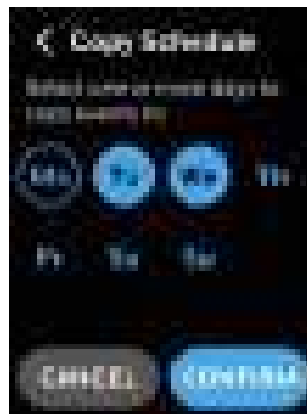

4. Tap **CONFIRM**.
Holiday copied successful confirmation message appears.

Figure 122 Copy successful

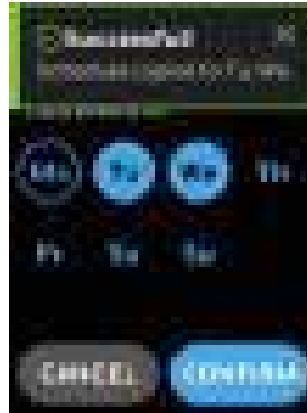

Special event

Special events are one time events that are different from the weekly schedule.

To create a special event

1. Right swipe the home screen.
2. On the Quick access screen, tap **Schedule** and then tap **Special Event**.
The Special Event screen appears.

Figure 123 Special event screen



3. Tap the add button.
The **Create Special Event** screen appears. Date is mandatory to create a special event.

Figure 124 Create special event

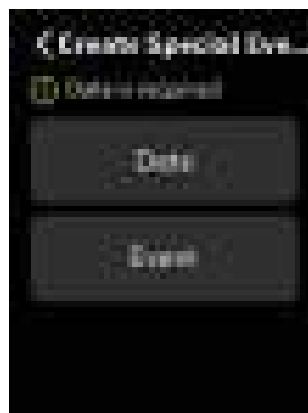

4. Tap **Date**.
The Set Date screen appears.

Figure 125 Set date screen

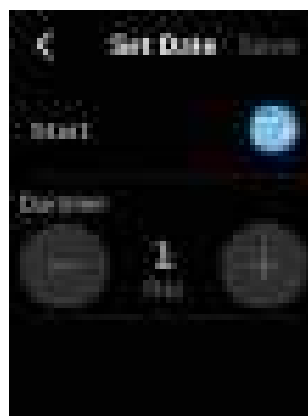

5. Select a date.

Note: *The thermostat supports special event configuration only for three years from the current date.*

If the special event reoccurs on multiple days, then increase the holiday count.

6. Tap **Done**.
The **Create Special Event** screen appears.
7. Tap **Event**.
Event list screen for the set date appears. You can add a maximum of four special events for the particular date.

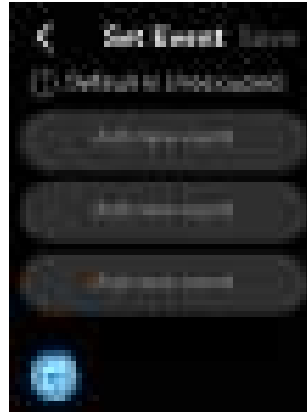
Figure 126 Adding new event

8. Tap **Add new event**.
The Create Event screen appears.
9. Tap the clock icon for Start.
10. Set the special event start time and then tap **CONFIRM**.
11. Tap the clock for End.
12. Set the special event end time and then tap **CONFIRM**.
13. Tap Occupied or Standby based on your requirement.
14. Tap **SAVE**.
The created special event appears under the special event date screen.
15. Tap **Save**.
16. Tap **Done**.
You have created a special event.

To delete a special event

1. On the special event screen, tap a special event.
A confirmation message appears.
2. Tap **DELETE**.
The special event is deleted.

Note: *Elapsed Special Events will automatically be deleted by the system.*

