

---

**Data Book**

T\_tAVDW\_1119\_EN - HFC R410A

---

# t-AV DW

8-156 kW

Direct expansion air conditioners for IT Cooling.  
Equipped with built-in water-cooled condenser.



The picture of the unit is indicative and may vary depending on the model



- Perimeter installation
- Fully hermetic ON/OFF compressors
- Single or double refrigerant circuit
- Air delivery from the bottom or from the top
- Plug fans with EC electric motor
- Electronic expansion valve
- Air suction temperature up to 40°C

**INDEX**

CERTIFICATIONS .....	4
GENERAL CHARACTERISTICS .....	5
INSTALLATION .....	6
PRODUCT FEATURES AND BENEFITS .....	6
F-GAS DIRECTIVE .....	6
MODEL IDENTIFICATION .....	7
TRANSPORT AND STORAGE TEMPERATURE .....	7
WORKING LIMITS .....	8
MAIN COMPONENTS .....	9
REMOTE DRY COOLERS .....	11
OPTIONAL ACCESSORIES .....	11
TECHNICAL DATA .....	14
REFRIGERANT CIRCUIT .....	19
PRESSURE RELIEF VALVE .....	21
WATER QUALITY OF THE HYDRAULIC CIRCUITS .....	22
ANTIFREEZE MIXTURES .....	22
ACOUSTIC DATA .....	23
ELECTRICAL DATA .....	24
MICROPROCESSOR CONTROL SYSTEM .....	25
DEMAND LIMIT .....	27
TEMPERATURE PROBE ON AIR RETURN / DELIVERY .....	27
CLOGGED FILTERS SENSOR .....	27
FLOOD SENSOR .....	27
POSSIBLE AIR INTAKE FOR OVER VERSIONS .....	28
REMOTE DRY COOLERS .....	29
OPTIONAL ACCESSORIES: P121 – FRONT AIR INTAKE+BOTTOM PANEL .....	30
OPTIONAL ACCESSORIES: P122 - BOTTOM AIR INTAKE+BLIND PANELS .....	30
OPTIONAL ACCESSORIES: 601 – SOLENOID VALVE ON LIQUID LINE .....	30
OPTIONAL ACCESSORIES: P201 - CONDENSER + 2WAY BALL VALVE .....	31
OPTIONAL ACCESSORIES: A548 - CONSTANT PREVALENCE .....	31
OPTIONAL ACCESSORIES: P091 - BACK-UP MODULE CONTROLLER .....	32
OPTIONAL ACCESSORIES: 383 – NUMBERED WIRINGS + UK REQUESTS .....	32
OPTIONAL ACCESSORIES: 4181 – SERIAL CARD MODBUS .....	32
OPTIONAL ACCESSORIES: 4182 – SERIAL CARD LON .....	32
OPTIONAL ACCESSORIES: 4184 – SERIAL CARD BACNET MS/TP RS485 .....	32
OPTIONAL ACCESSORIES: 4185 – SERIAL CARD BACNET OVER IP .....	32
OPTIONAL ACCESSORIES: A492 – WATER LEACKAGE DETECTOR + ADDITIONAL DETECTOR .....	33
OPTIONAL ACCESSORIES: A511 - SMOKE DETECTORS .....	33
OPTIONAL ACCESSORIES: A521 – FIRE DETECTORS .....	33
OPTIONAL ACCESSORIES: P141 – ANALOGUE SET-POINT COMPENSATION .....	33
OPTIONAL ACCESSORIES: P181 – NETWORK ANALYZER .....	34
OPTIONAL ACCESSORIES: P182 – NETWORK ANALYZER+OPTIONAL .....	34
OPTIONAL ACCESSORIES: P183 – KIT NETWORK ANALYZER .....	34
OPTIONAL ACCESSORIES: P184 – KIT NETWORK ANALYZER+OPTIONAL .....	34
OPTIONAL ACCESSORIES: A812 – FREE-COOLING DIRECT CONTROL .....	34
OPTIONAL ACCESSORIES: P131 – HOT WATER COIL+2WAY VALVE .....	35
OPTIONAL ACCESSORIES: A431 – ELECTRIC HEATERS .....	39
OPTIONAL ACCESSORIES: A432 – EXTRA POWER ELECTRIC HEATERS .....	39
OPTIONAL ACCESSORIES: 4301 – STEAM HUMIDIFIER 3KG/H .....	41
OPTIONAL ACCESSORIES: 4303 – STEAM HUMIDIFIER 8KG/H .....	41

OPTIONAL ACCESSORIES: 4305 – STEAM HUMIDIFIER 15KG/H.....	41
OPTIONAL ACCESSORIES : P051 – DEHUMIDIFICATION FUNCTION .....	44
OPTIONAL ACCESSORIES: P161 - T/RH AIR INTAKE SENSOR.....	44
OPTIONAL ACCESSORIES: P071 - REMOTE T/RH PROBE .....	44
OPTIONAL ACCESSORIES: 4666 – EXTERNAL AIR PROBE .....	44
OPTIONAL ACCESSORIES: P111 – DUAL POWER SUPPLY .....	45
OPTIONAL ACCESSORIES: P112 – DUAL POWER SUPPLY + OPTIONAL.....	45
OPTIONAL ACCESSORIES: P113 – KIT DUAL POWER SUPPLY .....	45
OPTIONAL ACCESSORIES: P114 – KIT DUAL POWER SUPPLY + OPTIONAL .....	45
OPTIONAL ACCESSORIES: A381 - DRAIN PUMP .....	46
OPTIONAL ACCESSORIES: P084 – AIR FILTER EPM <sub>10</sub> 50% .....	47
OPTIONAL ACCESSORIES: A531 – ON-OFF DAMPER .....	48
OPTIONAL ACCESSORIES: P011 - EMPTY PLENUM .....	50
OPTIONAL ACCESSORIES: P012 - EMPTY PLENUM CL.A1 .....	50
OPTIONAL ACCESSORIES: P031 - EMPTY INTAKE PLENUM .....	50
OPTIONAL ACCESSORIES: P032 - EMPTY INTAKE PLENUM CL.A1 .....	50
OPTIONAL ACCESSORIES: P013 - PLENUM + 3 GRILLES .....	50
OPTIONAL ACCESSORIES: P014 - PLENUM + 3 GRILLES CL.A1 .....	50
OPTIONAL ACCESSORIES: P015 - SILENCED PLENUM .....	50
OPTIONAL ACCESSORIES: P016 - SILENCED PLENUM + 1 GRILLE .....	50
OPTIONAL ACCESSORIES: P017 - PLENUM + FILTER EPM2.5 50%.....	50
OPTIONAL ACCESSORIES: P018 - PLENUM + FILTER EPM1 50%.....	50
OPTIONAL ACCESSORIES: P019 - PLENUM + FILTER EPM1 85%.....	50
OPTIONAL ACCESSORIES: P034 – INTAKE FREE-COOLING PLENUM .....	57
OPTIONAL ACCESSORIES: P041 – SUPPORT FRAME H 255-350MM.....	61
OPTIONAL ACCESSORIES: P042 – SUPPORT FRAME H 355-450MM.....	61
OPTIONAL ACCESSORIES: P043 – SUPPORT FRAME H 400-510MM.....	61
OPTIONAL ACCESSORIES: 3601 – COMPRESSOR OPERATING SIGNAL CONTACT .....	61
OPTIONAL ACCESSORIES: 2411 – PHASE SEQUENCE RELAY .....	62
OPTIONAL ACCESSORIES: 1511 – SOFT STARTER.....	62
OPTIONAL ACCESSORIES: 3301 – COMPRESSOR REPHASING.....	63
OPTIONAL ACCESSORIES: A181 – COMPRESSOR SOUNDPROOF JACKET.....	63
OPTIONAL ACCESSORIES: A272 – CL.0 OR A1 (EN13501-1) INSULATION.....	63
OPTIONAL ACCESSORIES: P151 – LOWERED DISPLAY FOR UNDER.....	63
MACHINE DRAWINGS .....	64
HOLE IN THE RAISED FLOOR FOR DOWNFLOW VERSION .....	81
EXAMPLE FOR MACHINES NOISE EMISSION CALCULATION.....	82
VALVE PRESSURE DROP CALCULATION AS FUNCTION OF WATER FLOW RATE.....	84
AIR FILTERS REPLACEMENT.....	85
SHIPMENT: PACKING DIMENSIONS.....	86
SHIPMENT: SHIPPING WEIGHT .....	86
SHIPMENT: OPTIONALS PACKING DIMENSIONS AND SHIPPING WEIGHT.....	87

### Liability disclaimer

The present publication is drawn up by of information only and does not constitute an offer binding upon Mitsubishi Electric Hydronics & IT Cooling Systems S.p.A. Mitsubishi Electric Hydronics & IT Cooling Systems S.p.A. has compiled the content of this publication to the best of its knowledge. The data contained herein are subject to change without notice. Mitsubishi Electric Hydronics & IT Cooling Systems S.p.A. explicitly rejects any liability for any direct or indirect damage, in the broadest sense, arising from or related to the use and/or interpretation of this publication. All content is copyrighted by Mitsubishi Electric Hydronics & IT Cooling Systems S.p.A.

CERTIFICATIONS

SYSTEM CERTIFICATIONS



**ISO 9001 CERTIFICATION**  
Quality Management System



**ISO 14001 CERTIFICATION**  
Environmental Management System



**BS OHSAS 18001 CERTIFICATION**  
Occupational Health and Safety Management System

PRODUCT CERTIFICATIONS BY COUNTRY



**CE MARKING**



**CCC – CQC CERTIFICATION**  
(People's Republic of China)



**EAC CERTIFICATION**  
(Russian Federation, Belarus, Kazakhstan)



## GENERAL CHARACTERISTICS



**UNDER**  
Downflow air delivery



**OVER**  
Upflow air delivery

**Air Conditioners for IT Cooling** with built-in water-cooled condenser.

This series is offered in 22 models available in the following versions:

- The upflow version (Over) is characterized by air intake from the front through honeycomb grille and air delivery from the top of the unit.
- The downflow version (Under) is characterized by air intake from the top and air delivery from the bottom of the unit.

Cooling capacity: 8 ÷ 156 kW

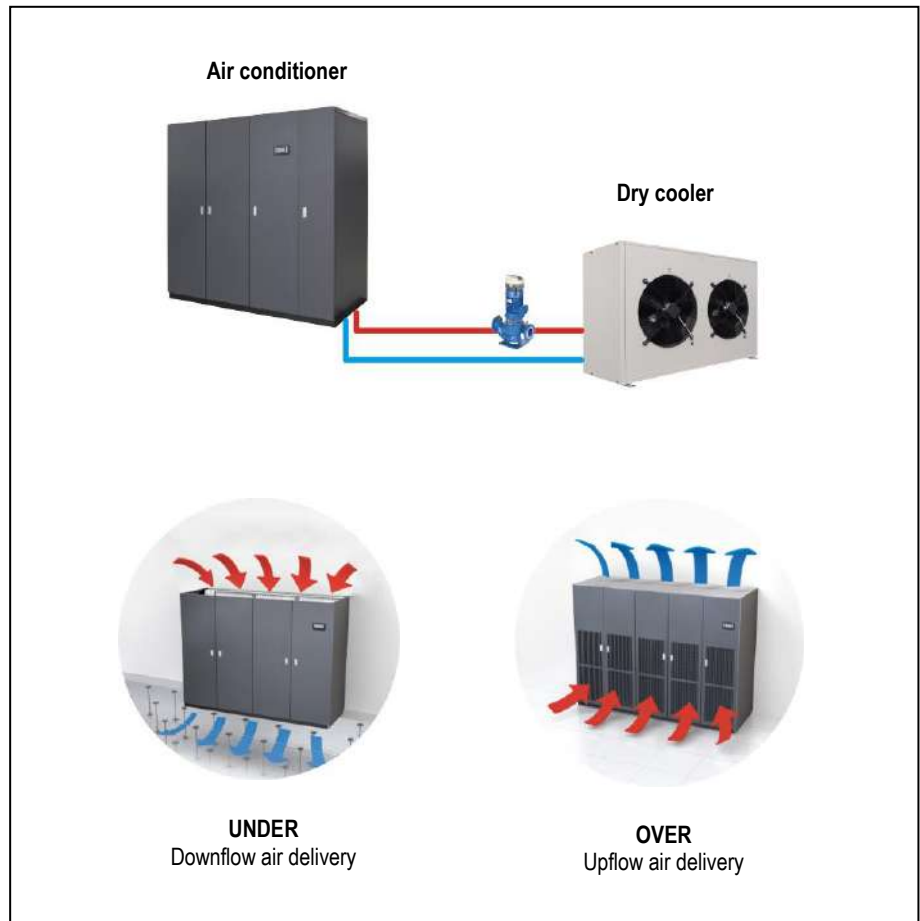

The machines are made for indoor installation.

The constructive solutions and the internal lay-out allow high application flexibility and the frontal access to the main components for the inspection and routine maintenance.

The installation requires electrical and hydraulic connections.

Final assembly on all machines before shipment including running test, reading and monitoring of operating parameters, alarms simulation and visual check.

## INSTALLATION

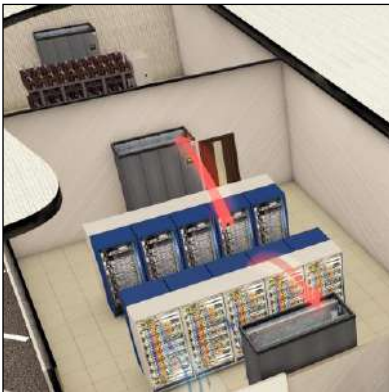
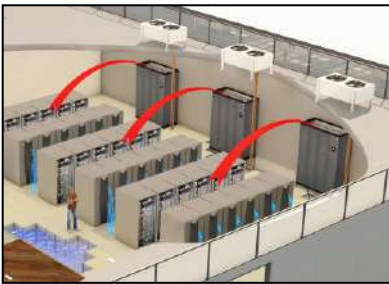

The series is particularly suitable for installation in Data Center of medium / small size with constant load.

### DOWNFLOW VERSION (Under)

Typical installation is on the perimeter.

The units are placed along the perimeter of the Data Center. Air suction from the top of the unit and air delivery in the underfloor void.

The air distribution is achieved by special tiles placed in front of the racks row, forming cold aisle for air diffusion. On the rear of the racks is expelled the hot then aspirated by the unit.

For an optimal installation is advisable to provide the cold aisle containment.



Some solutions provide a service corridor around the server rooms where to place the units. In this case, it is necessary to provide the air intake plenum for each unit. With this solution, all the space in the Data Center is available for the installation of racks.

### UPFLOW VERSION (Over)

The type of installation is practically similar to the previous. The only difference is that for the air distribution in the Data Center is not used the raised floor but ducts in the ceiling.



The series is also suitable for installation in UPS, Batteries, Distribution rooms and in all service areas of the Data Center that need a service of conditioning.

### OPTIONAL

An extensive list of accessories allows the unit to adapt effectively to the real needs of the system, reducing the time and cost of installation.

## PRODUCT FEATURES AND BENEFITS

- EER up to 5,56;
- New plug fans with EC electric motors and impeller in composite material, which guarantees a reduction of power consumption;
- Electronic expansion valve
- New fans electric motor that do not require maintenance;
- Improvement of the control software with advanced control logic;
- Single or double refrigerant circuit;
- Air suction temperature up to 40°C

## F-GAS DIRECTIVE

The units highlighted in this publication contain <HFC R410A [GWP<sub>100</sub> 2088]> fluorinated greenhouse gases.

## MODEL IDENTIFICATION









### Air conditioners for IT Cooling

model: t-AV DW O 041 P1 S E4L









<b>t-AV</b>	<b>Series</b>
<b>DW</b>	<b>Unit type</b> DW – direct expansion, water cooled
<b>O</b>	<b>Air delivery</b> O = over – upflow air delivery U = under – downflow air delivery
<b>041</b>	<b>Model / Cooling capacity (kW) at nominal conditions</b>
<b>P1</b>	<b>Compressor type and number</b> P = scroll compressor for R410A 1 = number of compressors
<b>S</b>	<b>Refrigerant circuit</b> S = single D = double
<b>E4L</b>	<b>Size</b>

**THE RANGE**

**UNDER**

	<b>E1</b>	<b>E2</b>	<b>E3</b>	<b>E4L</b>	<b>E5L</b>	<b>E6L</b>	<b>E7L</b>	<b>E8L</b>	<b>E9L</b>
									

**OVER**

	<b>E1</b>	<b>E2</b>	<b>E3</b>	<b>E4L</b>	<b>E5L</b>	<b>E6L</b>	<b>E7L</b>	<b>E8L</b>
								

## TRANSPORT AND STORAGE TEMPERATURE

During transport and if the machine is not installed at the reception, do not remove the packaging and place the machine in an enclosed, dry and protected from sunlight site at temperatures ranging between -30°C and 45°C in absence of superficial condensation.

WORKING LIMITS

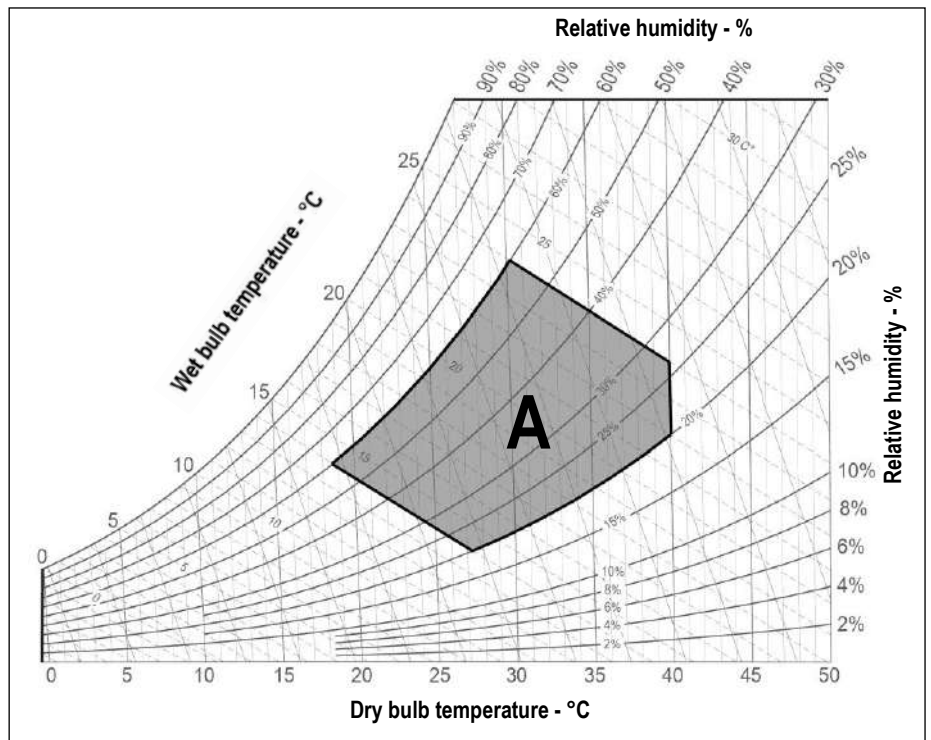

ROOM AIR CONDITIONS

Room air temperature:

- 14°C minimum temperature with wet bulb.
- 24°C maximum temperature with wet bulb.
- 18°C minimum temperature with dry bulb
- 40°C maximum temperature with dry bulb.

AREA "A". Machine operating envelope.

Room air humidity:

- 20%RH minimum relative humidity.
- 60%RH maximum relative humidity.

WATER COOLED CONDENSER

Inlet water temperature:

- 6-20°C Inlet water temperature range – the 2-way valve optional for condensing control is required.
- 20-50°C Inlet water temperature range – without necessarily using the 2-way valve optional for condensing control.

Outlet water temperature:

- 25-55°C Outlet water temperature range

Operating  $\Delta T$ :

- 4-20°C Operating  $\Delta T$  between water inlet / outlet

All the values are indicative. The working temperatures are influenced by a series of variables as:

- Working conditions;
- Thermal load;
- Set of the microprocessor control.

HYDRAULIC CIRCUIT

- 10 Bar Maximum working pressure of the hydraulic circuit

POWER SUPPLY

- $\pm 10\%$  Maximum tolerance of the supply voltage (V)
- $\pm 2\%$  Maximum unbalancing of the phases.



## MAIN COMPONENTS



### FRAMEWORK

- Base in aluminium extrusion, painted with epoxy powders. Colour RAL 9005;
- Frame in aluminium profile, painted with epoxy powders. The inner frame is provided with seals for the panels. Colour RAL 9005;
- Panels in galvanized steel sheet with protective surfaces treatment in compliance with UNI ISO 9227/ASTMB117 and ISO 7253, and painted with epoxy powders. Colour RAL 7016 hammered;
- Panels insulated with polyurethane foam and seals to ensure air tight.
- Hinged front panels with quick release removal system.
- Total front access for routine maintenance.
- Removable lateral and back side panels.
- Air flow OVER version:
  - Air intake from the front through honeycomb type grille and air delivery from the top.
- Air flow UNDER version:
  - Air intake from the top and air delivery from the bottom.
- Compartment for electrical panel on unit front for direct access to control and regulation devices;

### FILTER SECTION

- Washable air filters with COARSE 60% efficiency (according to ISO EN 16890), with cells in synthetic fibre and metallic frame.
- Air filters access:
  - OVER version
    - Frontal access for all machines
  - UNDER version
    - For machines size E1 – E2 – E3 frontal access
    - For machine size E4L – E5L – E6L – E7L – E8L – E9L access from upper side
- Clogged filters sensor with differential pressure switch on air side.

### ON / OFF COMPRESSORS SECTION

Units size E1 and E2:

- Rotary vane compressors for R410A refrigerant
- 2-pole 3-phase electric motor with direct on line starting.
- Crankcase heater.
- Rubber supports.

Units size E3, E4L, E5L, E6L, E7L, E8L and E9L

- Scroll rotary compressors with spiral profile optimized for R410A refrigerant.
- 2-pole 3-phase electric motor with direct on line starting.
- Crankcase heater.
- Rubber supports.

### FANS SECTION

The fan section is contained within the machine and includes:

- Centrifugal fans with backward curved blades with wing profile, single suction and without scroll housings (Plug-fans), directly coupled to external rotor electric motor.
- Impeller in composite material exempt from rust formation.
- Brushless type synchronous EC motor with integrated electronic commutated system and continuous variation of the rotation speed. The motor rotation control is obtained with the EC system (Electronic Commutation) that manage the motor according to the signal coming from the microprocessor control.
- Fans control through ModBus. In case of failure, the control stops the interested fan indicating the type of fault. The machine with more than one fan is not stopped.
- Adjustable External Static Pressure (ESP).
- Fan guard with rubber support (UNDER version)



#### COOLING SECTION

- Heat exchanger coil with internally corrugated copper tubes and high efficiency aluminium fins, specifically developed to provide high heat transfer and lower pressure drops.
- Frame in galvanized steel or peraluman.
- Condensate tray in peraluman with PVC flexible discharge pipe.
- Temperature sensor on air intake with control and regulation functions.
- Temperature sensor on air delivery with function of temperature display.
- Under floor water alarm through sensor to be placed on the floor.



#### CONDENSING SECTION

- Copper brazed plate type with cover plates, plates and connections in AISI 316 stainless steel.
- 0÷10V proportional signal to manage the condensing control system.

#### REFRIGERANT CIRCUIT

Components for each refrigerant circuit:

- Electronic expansion valve. The valve allows high performance and system efficiency thanks to a timely and accurate response to changes in temperature and pressure.
- Sight glass.
- Filter dryer on liquid line.
- Pressure transducers with indication, control and protection functions, on low and high refrigerant pressure.
- High pressure safety switch with manual reset.
- Liquid receiver.
- Pressure relief valve on liquid receiver for models 041 P1, 045 P1, 075 P2, 082 P2, 092 P2, 102 P2, 117 P4, 146 P4.
- Refrigerant circuit with copper tubing with anticondensate insulation of the suction line.
- R410A refrigerant charge and lubricant oil.

#### ELECTRICAL PANEL

In accordance with EN60204-1 norms, suitable for indoor installation, complete with:

- Main switch with door lock safety on frontal panel.
  - Magnetothermic switches for each compressor.
  - Magnetothermic switches for supply fans.
  - Contactors for each load. The supply fans equipped with EC electric motor don't require contactors.
  - Transformer for auxiliary circuit and microprocessor supply.
  - Numbered wirings.
  - Terminals:
- OUTLETS
- Voltage free deviating contact for General Alarm 1–2.
  - Voltage free contact for supply fans status.
  - Voltage free contact for smoke / fire sensor (the sensors are accessory)
- INLETS
- External enabling.
- Power supply 400/3+N/50.



#### CONTROL SYSTEM

Microprocessor control system with graphic display for control and monitor of operating and alarms status. The system includes:

- Built-in clock for alarms date and time displaying and storing;
- Built-in memory for the storing of the intervened events (up to 200 events recorded);
- Predisposition for additional connectivity board housing (MODBUS, LON, BACNET MS/TP RS485, BACNET OVER IP). The electronic cards are optional accessories.
- Main components hour-meter;
- Non-volatile "Flash" memory for data storage in case of power supply faulty;
- Menu with protection password;
- Demand Limit function (for machines with double refrigerant circuit only);
- LAN connection (max 10 units).



## REMOTE DRY COOLERS

The descriptions of these series can be found in Chapter REMOTE DRY COOLERS

..... **Remote dry cooler:** Remote dry cooler with coil in copper tubes and aluminium fins and AC axial fans series: **BVE DC-A**

## OPTIONAL ACCESSORIES

The descriptions of these additional components can be found in Chapter OPTIONAL ACCESSORIES.

P121.....	<b>Front air intake + bottom panel.</b> Unit base noise insulation with special bottom panel for OVER version. Restriction: Non-compatible with "P122 Bottom air intake + blind panels" for OVER version.
P122.....	<b>Bottom air intake+blind panels.</b> Blind frontal panel for OVER version. The accessory allows the intake air from the bottom of the machine. Restriction: Not compatible with "P121 Front air intake + bottom panel" for OVER version.
601.....	<b>Solenoid valve on liquid line.</b>
P201.....	<b>Condenser + 2way ball valve.</b> Condensing control with 2-way motorized valve, 0÷10 VDC control actuator and emergency manual control.
A548.....	<b>Constant prevalence.</b> Automatic system for the air pressure control in the aisle. The system controls the supply fans rotation speed to keep constant the air pressure via a differential pressure transmitter connected to the microprocessor control.
P091.....	<b>Back-up module controller.</b> The system guarantees the microprocessor power supply for a few minutes, in case of supply voltage failure. (size E1 excluded).
383.....	<b>Numbered wirings + UK requests;</b>
4181 / 4182 / 4184 / 4185...	<b>Serial cards:</b> 4181 – Serial card MODBUS; 4182 – Serial card LON; 4184 – Serial card BACNET MS/TP RS485; 4185 – Serial card BACNET OVER IP.
A492.....	<b>Water leakage detector + additional sensor.</b> Supplied in mounting kit.
A511.....	<b>Smoke detector.</b> Supplied in mounting kit.
A521.....	<b>Fire detector.</b> Supplied in mounting kit.
P141.....	<b>Analogue set-point compensation.</b> - Analogue set point compensation according to an external analogue signal at Customer care.
P181.....	<b>Network analyser (standard machine)</b> Multifunction utility for calculating and displaying the machine electrical measurements.
P182.....	<b>Network analyser+optional (full optional machine)</b> Multifunction utility for calculating and displaying the machine electrical measurements.
P183.....	<b>Kit network analyser (standard machine)</b> Multifunction utility for calculating and displaying the machine electrical measurements. Supplied in mounting kit.
P184.....	<b>Kit network analyser+optional (full optional machine)</b> Multifunction utility for calculating and displaying the machine electrical measurements. Supplied in mounting kit.
A812 (1).....	<b>Free-cooling direct control.</b>
P131.....	<b>Hot water coil + 2-way valve.</b> Hot water heating system.
A431.....	<b>Electric heater.</b> Heating with electric heaters.
A432.....	<b>Extra power electric heater.</b> Size E1, E2 excluded.
4301 / 4303 / 4305 (2).....	<b>Humidification:</b> Modulating steam humidifier with immersed electrodes with electronic control. 4301 - Steam humidifier 3kg/h 4303 - Steam humidifier 8kg/h 4305 - Steam humidifier 15kg/h
P051 (3).....	<b>Dehumidification function.</b>
P161.....	<b>T/rH air intake sensor.</b> Combined Temperature / Humidity sensor on air intake. The optional replace the standard temperature sensor on machine air intake.
4666.....	<b>External air probe.</b> External air temperature probe.
P071.....	<b>Remote T/rH probe.</b> Combined Temperature / Humidity sensor for remote installation. The optional is added to the standard temperature sensor on machine air intake.

P111 / P112 / P113 / P114	<b>Dual power supply.</b> Dual power supply with automatic change-over. <b>P111 - Dual power supply.</b> <b>P112 - Dual power supply + optional.</b> <b>P113 - Dual power supply kit.</b> Supplied in mounting kit <b>P114 - Dual power supply kit + optional.</b> Supplied in mounting kit
A381	<b>Drain pump.</b> Supplied in mounting kit. The system includes pump with activation float and 10 linear meters long discharge pipe.
P084	<b>Air filter ePM<sub>10</sub> 50%.</b> Washable high efficiency air filter (according to ISO EN 16890). Not compatible with "P017 / P018 / P019 Plenum + filter ePM <sub>2,5</sub> 50%, ePM <sub>1</sub> 50%, ePM <sub>1</sub> 85% (according to ISO EN 16890)".
A531 (4)	<b>On-off damper.</b> Non-return air damper with frame driven by electric servomotor installed on the machine air delivery.
P011	<b>Empty plenum.</b>
P012	<b>Empty plenum CL.A1.</b> Plenum with fire reaction in class "0" or "A1". (size E0 excluded).
P013	<b>Plenum + 3 grilles</b> on three sides with double adjustable row.
P014	<b>Plenum + 3 grilles CL.A1.</b> Plenum with grilles on three sides with double adjustable row, with fire reaction in class "0" or "A1".
P015	<b>Silenced plenum.</b> Not compatible with "P084 Air filter ePM10 50%".
P016	<b>Silenced plenum + 1 grille.</b> Grille with double adjustable row on front side and sound absorbers.
P017	<b>Plenum + filter ePM<sub>2,5</sub> 50%.</b> Plenum with high efficiency air filter (according to ISO EN 16890). Not compatible with "P084 Air filter ePM10 50%".
P018	<b>Plenum + filter ePM<sub>1</sub> 50%.</b> Plenum with high efficiency air filter (according to ISO EN 16890). Not compatible with "P084 Air filter ePM10 50%".
P019	<b>Plenum + filter ePM<sub>1</sub> 85%.</b> Plenum with high efficiency air filter (according to ISO EN 16890). Not compatible with "P084 Air filter ePM10 50%".
P031 (5)	<b>Empty intake plenum.</b>
P032 (5)	<b>Empty intake plenum CL.A1.</b> Plenum with fire reaction in class "0" or "A1".
P034 (6)	<b>Intake free-cooling plenum.</b>
P041 / P042 / P043	<b>Support frame</b> with height adjusting rubber holders. Supplied in mounting kit. It is not possible to match the support frame with plenum installed under the machine. <b>P041 – Support frame h 255-350mm</b> <b>P042 – Support frame h 355-450mm</b> <b>P043 – Support frame h 400-510mm</b>
3601	<b>Compressor operating signal contact.</b> Voltage free contact for compressor status signalling.
2411	<b>Phase sequence relay.</b> Phases sequence control relay for the machine.
1511	<b>Soft starter.</b> Compressor motors soft-starter system (size E1, E2 excluded).
3301	<b>Compressor rephasing.</b> Compressors capacitor for power factor - cosφ 0,9 (sizes E1, E2 excluded).
A181	<b>Compressor soundproof jacket.</b> Compressor soundproof jacket for a sound level reduction of 2 dB(A).
A272	<b>CL. 0 or A1 (EN 13501-1) insulation:</b> Panelling with fire reaction in class "0" or "A1";
P151	<b>Lowered display for Under</b> – for UNDER units equipped with plenum under the unit.
9973	<b>Wooden cage packing.</b> The machines are delivered on wooden pallet, covered with shrink wrap and packaged in wooden cage.
BQ39900001	<b>Remote terminal.</b> Graphic display for remote installation, the optional is added to the standard graphic display placed on machine frontal panel.

**WARNING**

The Manufacturers reserves the right to accept the matching of the optional installed on the machine.

**MANDATORY COMBINATIONS OF ACCESSORIES**

1. When optional accessory "A812 Free cooling direct control" is present, it requires mandatory accessories "P161 T/rH air intake sensor" and "4666 External air probe".
2. When optional accessories "4301 / 4303 / 4305 Steam humidifier" are present, they require mandatory accessory "P161 T/rH air intake sensor".
3. When optional accessory "P051 Dehumidification function" is present, it requires mandatory accessory "P161 T/rH air intake sensor".
4. When optional accessory "A531 On-off damper" is present, it requires mandatory accessory "9973 Wooden cage packing".
5. When optional accessories "P031 Empty intake plenum, for OVER version" and "P032 Empty intake plenum CL.A1, for OVER version" are present, they require mandatory accessory "P122 Bottom air intake+blind panels, for OVER version only".
6. When optional accessory "P034 Intake free-cooling plenum" is present, it requires mandatory accessories "P161 T/rH air intake sensor", "4666 External air probe", "A812 Free-cooling direct control" and "P122 Bottom air intake+blind panels, for OVER version only".

## TECHNICAL DATA

VERSION (1)		U / O	U / O	U / O	U / O	U / O
MODEL		007 P1 S	009 P1 S	011 P1 S	014 P1 S	016 P1 S
SIZE		E1	E1	E1	E2	E2
<b>COOLING CAPACITY (2)</b>						
<b>Total</b>	kW	7,89	9,39	11,0	14,5	16,3
<b>Sensible</b>	kW	7,89	9,39	10,5	14,5	14,8
SHR (3)		1	1	0,95	1	0,91
Total power input (Comp. + Fans)	kW	1,42	1,77	2,28	2,87	3,31
Condenser water flow rate	m <sup>3</sup> /h	1,59	1,91	2,24	2,93	3,29
Condenser pressure drop	kPa	22,1	30,9	25,5	20,4	25,4
<b>"EC" SUPPLY FANS</b>	n.	1	1	1	1	1
Air flow	m <sup>3</sup> /h	2500	2700	2800	4000	4200
Nominal external static pressure	Pa	20	20	20	20	20
Maximum external static pressure	Pa	245	218	86	343	291
Fans power input (4)	kW	0,12	0,14	0,28	0,48	0,55
<b>ON/OFF COMPRESSORS</b>		rotary vane	rotary vane	rotary vane	rotary vane	rotary vane
Compressors number	n.	1	1	1	1	1
Capacity steps	n.	1	1	1	1	1
Compressors power input	kW	1,30	1,63	2,00	2,39	2,75
<b>WATER COOLED CONDENSER</b>		1	1	1	1	1
Water volume	l	0,5	0,5	0,7	1,1	1,1
Max water flow rate	m <sup>3</sup> /h	2	2,5	2,9	3,8	4,1
<b>AIR FILTERS</b>	n.	1	1	1	1	1
Filter area	m <sup>2</sup>	0,61	0,61	0,61	0,78	0,78
Efficiency (ISO EN 16890)	COARSE	60%	60%	60%	60%	60%
<b>REFRIGERANT</b>		R410A	R410A	R410A	R410A	R410A
Refrigerant circuit x Refrigerant charge (5)	n x kg	1 x 3,3	1 x 3,3	1 x 3,3	1 x 3,6	1 x 3,6
HFC R410A - F Gas - CO <sub>2</sub> equivalent	t	6,9	6,9	6,9	7,5	7,5
<b>POWER SUPPLY</b>	V/Ph/Hz	400/3+N/50	400/3+N/50	400/3+N/50	400/3+N/50	400/3+N/50
<b>ENERGY EFFICIENCY INDEX (2)</b>						
EER Energy Efficiency Ratio	kW/kW	5,56	5,31	4,82	5,05	4,92
<b>DIMENSIONS</b>						
Length	mm	650	650	650	785	785
Width	mm	675	675	675	675	675
Height	mm	1925	1925	1925	1925	1925
<b>NET WEIGHT OVER</b>	kg	235	237	240	275	280
<b>NET WEIGHT UNDER</b>	kg	245	247	250	285	290
<b>CONNECTIONS ISO 228/1-G</b>						
Condenser water inlet/outlet	M Ø	1"	1"	1"	1"	1"
<b>HYDRAULIC CONNECTIONS</b>						
<b>CONDENSATE DISCHARGE</b>						
Rubber pipe – internal diameter	Ø mm	19	19	19	19	19

### THE COOLING CAPACITY DOES NOT CONSIDER THE SUPPLY FAN MOTOR THERMAL LOAD

1. U = Under, downflow / O = Over, upflow
2. Gross value. Characteristics referred to entering air at 26°C-40%RH; water to the condenser 30-35°C. ESP=20Pa.
3. SHR = Sensible cooling capacity / Total cooling capacity.
4. Corresponding to the nominal external static pressure
5. **The air conditioner is supplied charged with R410A refrigerant charge.** Unit refrigerant charge optional excluded. For air conditioners with double refrigerant circuit is indicated the number of circuits x the charge of a single circuit.

The units highlighted in this publication contain <HFC R410A [GWP<sub>100</sub> 2088]> fluorinated greenhouse gas.

## TECHNICAL DATA

VERSION (1)		U / O	U / O	U / O	U / O	U / O
MODEL		020 P1 S	022 P1 S	026 P1 S	032 P1 S	037 P1 S
SIZE		E3	E3	E3	E4L	E4L
<b>COOLING CAPACITY (2)</b>						
Total	kW	21,2	23,0	27,8	34,4	39,5
Sensible	kW	21,2	23,0	26,5	34,4	39,5
SHR (3)		1	1	0,95	1	1
Total power input (Comp. + Fans)	kW	4,00	4,86	5,97	6,71	8,20
Condenser water flow rate	m <sup>3</sup> /h	4,22	4,65	5,66	6,88	7,93
Condenser pressure drop	kPa	20,8	24,6	18,9	27,3	35,4
<b>"EC" SUPPLY FANS</b>						
"EC" number	n.	1	1	1	1	1
Air flow	m <sup>3</sup> /h	5700	6100	6400	8700	10000
Nominal external static pressure	Pa	20	20	20	20	20
Maximum external static pressure	Pa	1000	1000	966	883	612
Fans power input (4)	kW	0,83	1,01	1,16	1,33	1,96
<b>ON/OFF COMPRESSORS</b>						
Compressors number	n.	1	1	1	1	1
Capacity steps	n.	1	1	1	1	1
Compressors power input	kW	3,17	3,85	4,81	5,38	6,24
<b>WATER COOLED CONDENSER</b>						
Water volume	l	1,9	1,9	2,8	2,8	2,8
Max water flow rate	m <sup>3</sup> /h	5,4	6	7,2	8,8	9,9
<b>AIR FILTERS</b>						
Filter area	m <sup>2</sup>	1,24	1,24	1,24	2,07	2,07
Efficiency (ISO EN 16890)	COARSE	60%	60%	60%	60%	60%
<b>REFRIGERANT</b>						
Refrigerant circuit x Refrigerant charge (5)	n x kg	1 x 4,4	1 x 4,4	1 x 4,5	1 x 6,2	1 x 6,2
HFC R410A - F Gas - CO <sub>2</sub> equivalent	t	9,2	9,2	9,4	12,9	12,9
<b>POWER SUPPLY</b>						
	V/Ph/Hz	400/3+N/50	400/3+N/50	400/3+N/50	400/3+N/50	400/3+N/50
<b>ENERGY EFFICIENCY INDEX (2)</b>						
EER Energy Efficiency Ratio	kW/kW	5,30	4,73	4,66	5,13	4,82
<b>DIMENSIONS</b>						
Length	mm	1085	1085	1085	1630	1630
Width	mm	775	775	775	930	930
Height	mm	1925	1925	1925	1980	1980
<b>NET WEIGHT OVER</b>						
	kg	320	325	325	500	500
<b>NET WEIGHT UNDER</b>						
	kg	340	345	345	510	510
<b>CONNECTIONS ISO 228/1-G</b>						
Condenser water inlet/outlet	M Ø	1 1/4"	1 1/4"	1 1/4"	1 1/2"	1 1/2"
<b>HYDRAULIC CONNECTIONS</b>						
<b>CONDENSATE DISCHARGE</b>						
Rubber pipe – internal diameter	Ø mm	19	19	19	19	19

### THE COOLING CAPACITY DOES NOT CONSIDER THE SUPPLY FAN MOTOR THERMAL LOAD

1. U = Under, downflow / O = Over, upflow
2. Gross value. Characteristics referred to entering air at 26°C-40%RH; water to the condenser 30-35°C. ESP=20Pa.
3. SHR = Sensible cooling capacity / Total cooling capacity.
4. Corresponding to the nominal external static pressure
5. **The air conditioner is supplied charged with R410A refrigerant charge.** Unit refrigerant charge optional excluded. For air conditioners with double refrigerant circuit is indicated the number of circuits x the charge of a single circuit.

The units highlighted in this publication contain <HFC R410A [GWP<sub>100</sub> 2088]> fluorinated greenhouse gas.

## TECHNICAL DATA

VERSION (1)		U / O	U / O	U / O	U / O	U / O
MODEL		041 P1 S	045 P1 S	039 P2 D	048 P2 D	055 P2 D
SIZE		E4L	E4L	E5L	E5L	E6L
<b>COOLING CAPACITY (2)</b>						
Total	kW	44,1	48,0	39,8	50,3	57,7
Sensible	kW	42,6	44,8	39,2	46,0	57,5
SHR (3)		0,97	0,93	0,98	0,91	1
Total power input (Comp. + Fans)	kW	8,85	9,87	8,23	11,2	12,0
Condenser water flow rate	m <sup>3</sup> /h	8,84	9,70	8,02	10,3	11,7
Condenser pressure drop	kPa	27,5	32,5	27,5	43,7	22,1
<b>"EC" SUPPLY FANS</b>						
"EC" SUPPLY FANS	n.	1	1	1	1	2
Air flow	m <sup>3</sup> /h	10800	10800	10000	12000	15000
Nominal external static pressure	Pa	20	20	20	20	20
Maximum external static pressure	Pa	588	588	674	451	993
Fans power input (4)	kW	1,85	1,85	1,76	2,15	2,21
<b>ON/OFF COMPRESSORS</b>						
ON/OFF COMPRESSORS		Scroll	Scroll	Scroll	Scroll	Scroll
Compressors number	n.	1	1	2	2	2
Capacity steps	n.	1	1	2	2	2
Compressors power input	kW	7,00	8,03	6,47	9,09	9,75
<b>WATER COOLED CONDENSER</b>						
WATER COOLED CONDENSER		1	1	1	1	1
Water volume	l	3,7	3,7	3	3	4,8
Max water flow rate	m <sup>3</sup> /h	11,3	12,3	10,1	13	15,1
<b>AIR FILTERS</b>						
AIR FILTERS	n.	2	2	3	3	3
Filter area	m <sup>2</sup>	2,07	2,07	2,59	2,59	3,16
Efficiency (ISO EN 16890)	COARSE	60%	60%	60%	60%	60%
<b>REFRIGERANT</b>						
REFRIGERANT		R410A	R410A	R410A	R410A	R410A
Refrigerant circuit x Refrigerant charge (5)	n x kg	1 x 9,3	1 x 9,3	2 x 4,9	2 x 4,9	2 x 5,5
HFC R410A - F Gas - CO <sub>2</sub> equivalent	t	19,4	19,4	20,3	20,3	23
<b>POWER SUPPLY</b>						
POWER SUPPLY	V/Ph/Hz	400/3+N/50	400/3+N/50	400/3+N/50	400/3+N/50	400/3+N/50
<b>ENERGY EFFICIENCY INDEX (2)</b>						
EER Energy Efficiency Ratio	kW/kW	4,98	4,86	4,84	4,49	4,81
<b>DIMENSIONS</b>						
Length	mm	1630	1630	1955	1955	2198
Width	mm	930	930	930	930	930
Height	mm	1980	1980	1980	1980	1980
<b>NET WEIGHT OVER</b>						
NET WEIGHT OVER	kg	505	505	635	635	690
<b>NET WEIGHT UNDER</b>						
NET WEIGHT UNDER	kg	515	515	645	645	710
<b>CONNECTIONS ISO 228/1-G</b>						
CONNECTIONS ISO 228/1-G						
Condenser water inlet/outlet	M Ø	1 1/2"	1 1/2"	2"	2"	2"
<b>HYDRAULIC CONNECTIONS</b>						
<b>CONDENSATE DISCHARGE</b>						
CONDENSATE DISCHARGE						
Rubber pipe – internal diameter	Ø mm	19	19	19	19	19

### THE COOLING CAPACITY DOES NOT CONSIDER THE SUPPLY FAN MOTOR THERMAL LOAD

1. U = Under, downflow / O = Over, upflow
2. Gross value. Characteristics referred to entering air at 26°C-40%RH; water to the condenser 30-35°C. ESP=20Pa.
3. SHR = Sensible cooling capacity / Total cooling capacity.
4. Corresponding to the nominal external static pressure
5. **The air conditioner is supplied charged with R410A refrigerant charge.** Unit refrigerant charge optional excluded. For air conditioners with double refrigerant circuit is indicated the number of circuits x the charge of a single circuit.

The units highlighted in this publication contain <HFC R410A [GWP<sub>100</sub> 2088]> fluorinated greenhouse gas.



## TECHNICAL DATA

VERSION (1)		U / O	U / O	U / O	U / O	U / O
MODEL		062 P2 D	075 P2 D	082 P2 D	092 P2 D	102 P2 D
SIZE		E6L	E7L	E7L	E8L	E8L
<b>COOLING CAPACITY (2)</b>						
Total	kW	65,2	79,4	87,2	97,5	109
Sensible	kW	62,5	77,7	82,1	91,0	97,2
SHR (3)		0,96	0,98	0,94	0,93	0,89
Total power input (Comp. + Fans)	kW	13,3	15,7	17,5	19,5	22,8
Condenser water flow rate	m <sup>3</sup> /h	13,2	15,9	17,6	19,7	22,3
Condenser pressure drop	kPa	27,6	23,5	28,2	22,6	28,5
<b>"EC" SUPPLY FANS</b>						
	n.	2	2	2	2	2
Air flow	m <sup>3</sup> /h	15600	20000	20000	22000	22000
Nominal external static pressure	Pa	20	20	20	20	20
Maximum external static pressure	Pa	941	679	679	601	601
Fans power input (4)	kW	2,46	3,30	3,30	3,55	3,55
<b>ON/OFF COMPRESSORS</b>						
		Scroll	Scroll	Scroll	Scroll	Scroll
Compressors number	n.	2	2	2	2	2
Capacity steps	n.	2	2	2	2	2
Compressors power input	kW	10,9	12,4	14,2	16,0	19,3
<b>WATER COOLED CONDENSER</b>						
		1	1	1	1	1
Water volume	l	6,4	6,4	6,4	10,4	10,4
Max water flow rate	m <sup>3</sup> /h	17	20,5	22,4	24,9	28,6
<b>AIR FILTERS</b>						
	n.	3	4	4	5	5
Filter area	m <sup>2</sup>	3,16	3,83	3,83	4,47	4,47
Efficiency (ISO EN 16890)	COARSE	60%	60%	60%	60%	60%
<b>REFRIGERANT</b>						
		R410A	R410A	R410A	R410A	R410A
Refrigerant circuit x Refrigerant charge (5)	n x kg	2 x 5,7	2 x 8,9	2 x 8,9	2 x 9,6	2 x 9,6
HFC R410A - F Gas - CO <sub>2</sub> equivalent	t	23,8	37,2	37,2	39,9	39,9
<b>POWER SUPPLY</b>						
	V/Ph/Hz	400/3+N/50	400/3+N/50	400/3+N/50	400/3+N/50	400/3+N/50
<b>ENERGY EFFICIENCY INDEX (2)</b>						
EER Energy Efficiency Ratio	kW/kW	4,90	5,06	4,98	5,00	4,78
<b>DIMENSIONS</b>						
Length	mm	2198	2499	2499	2899	2899
Width	mm	930	930	930	930	930
Height	mm	1980	1980	1980	1980	1980
<b>NET WEIGHT OVER</b>						
	kg	690	725	725	930	930
<b>NET WEIGHT UNDER</b>						
	kg	710	775	775	990	990
<b>CONNECTIONS ISO 228/1-G</b>						
Condenser water inlet/outlet	M Ø	2"	2 1/2"	2 1/2"	2 1/2"	2 1/2"
<b>HYDRAULIC CONNECTIONS</b>						
<b>CONDENSATE DISCHARGE</b>						
Rubber pipe – internal diameter	Ø mm	19	19	19	19	19

### THE COOLING CAPACITY DOES NOT CONSIDER THE SUPPLY FAN MOTOR THERMAL LOAD

1. U = Under, downflow / O = Over, upflow
2. Gross value. Characteristics referred to entering air at 26°C-40%RH; water to the condenser 30-35°C. ESP=20Pa.
3. SHR = Sensible cooling capacity / Total cooling capacity.
4. Corresponding to the nominal external static pressure
5. **The air conditioner is supplied charged with R410A refrigerant charge.** Unit refrigerant charge optional excluded. For air conditioners with double refrigerant circuit is indicated the number of circuits x the charge of a single circuit.

The units highlighted in this publication contain <HFC R410A [GWP<sub>100</sub> 2088]> fluorinated greenhouse gas.

## TECHNICAL DATA

VERSION (1)		U	U
MODEL		117 P4 D	146 P4 D
SIZE		E9L	E9L
<b>COOLING CAPACITY (2)</b>			
Total	kW	126	156
Sensible	kW	126	144
SHR (3)		1	0,92
Total power input (Comp. + Fans)	kW	27,7	34,7
Condenser water flow rate	m³/h	25,6	31,9
Condenser pressure drop	kPa	33,8	51,2
<b>"EC" SUPPLY FANS</b>			
	n.	3	3
Air flow	m³/h	33100	33100
Nominal external static pressure	Pa	20	20
Maximum external static pressure	Pa	538	538
Fans power input (4)	kW	5,97	5,97
<b>ON/OFF COMPRESSORS</b>			
		Scroll	Scroll
Compressors number	n.	4	4
Capacity steps	n.	4	4
Compressors power input	kW	21,8	28,7
<b>WATER COOLED CONDENSER</b>			
		1	1
Water volume	l	12	12
Max water flow rate	m³/h	31,7	39,9
<b>AIR FILTERS</b>			
	n.	-	-
Filter area	m²	5,24	5,24
Efficiency (ISO EN 16890)	COARSE	60%	60%
<b>REFRIGERANT</b>			
		R410A	R410A
Refrigerant circuit x Refrigerant charge (5)	n x kg	2 x 10,8	2 x 10,8
HFC R410A - F Gas - CO <sub>2</sub> equivalent	t	45,1	45,1
<b>POWER SUPPLY</b>			
	V/Ph/Hz	400/3+N/50	400/3+N/50
<b>ENERGY EFFICIENCY INDEX (2)</b>			
EER Energy Efficiency Ratio	kW/kW	4,55	4,50
<b>DIMENSIONS</b>			
Length	mm	3299	3299
Width	mm	930	930
Height	mm	1980	1980
<b>NET WEIGHT OVER</b>			
	kg	-	-
<b>NET WEIGHT UNDER</b>			
	kg	1140	1190
<b>CONNECTIONS ISO 228/1-G</b>			
Condenser water inlet/outlet	F Ø	3"	3"
<b>HYDRAULIC CONNECTIONS</b>			
<b>CONDENSATE DISCHARGE</b>			
Rubber pipe – internal diameter	Ø mm	19	19

### THE COOLING CAPACITY DOES NOT CONSIDER THE SUPPLY FAN MOTOR THERMAL LOAD

1. U = Under, downflow / O = Over, upflow
2. Gross value. Characteristics referred to entering air at 26°C-40%RH; water to the condenser 30-35°C. ESP=20Pa.
3. SHR = Sensible cooling capacity / Total cooling capacity.
4. Corresponding to the nominal external static pressure
5. **The air conditioner is supplied charged with R410A refrigerant charge.** Unit refrigerant charge optional excluded. For air conditioners with double refrigerant circuit is indicated the number of circuits x the charge of a single circuit.

The units highlighted in this publication contain <HFC R410A [GWP<sub>100</sub> 2088]> fluorinated greenhouse gas.

**REFRIGERANT CIRCUIT**

Below refrigerant diagrams for version with single or double refrigerant circuit. The diagrams refer to the standard configuration, without optional.

**UNDER - SINGLE REFRIGERANT CIRCUIT**

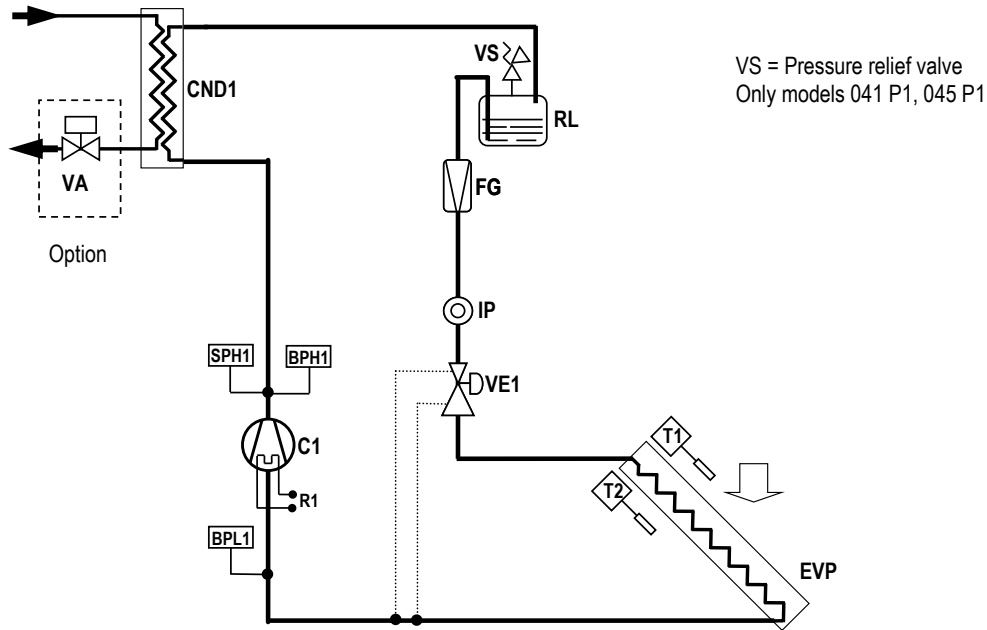

**OVER - SINGLE REFRIGERANT CIRCUIT**

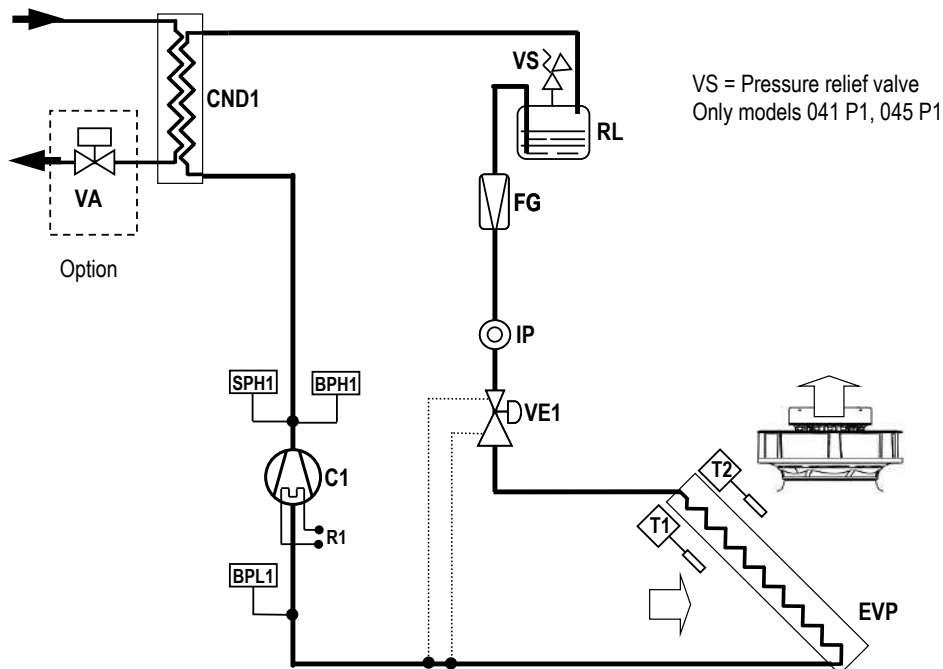

**LEGENDA**

C1 Compressor  
R1 Crankcase heater  
CND Condenser.  
EVP Evaporator.  
BPH High pressure transducer.

BPL Low pressure transducer.  
SPH High pressure switch  
VS Safety valve.  
FG Refrigerant filter.

IP Sight glass.  
VE Expansion valve.  
T Temperature probes.  
RL Liquid receiver  
VA Motorized valve for condensing control (option)

**UNDER - DOUBLE REFRIGERANT CIRCUIT**

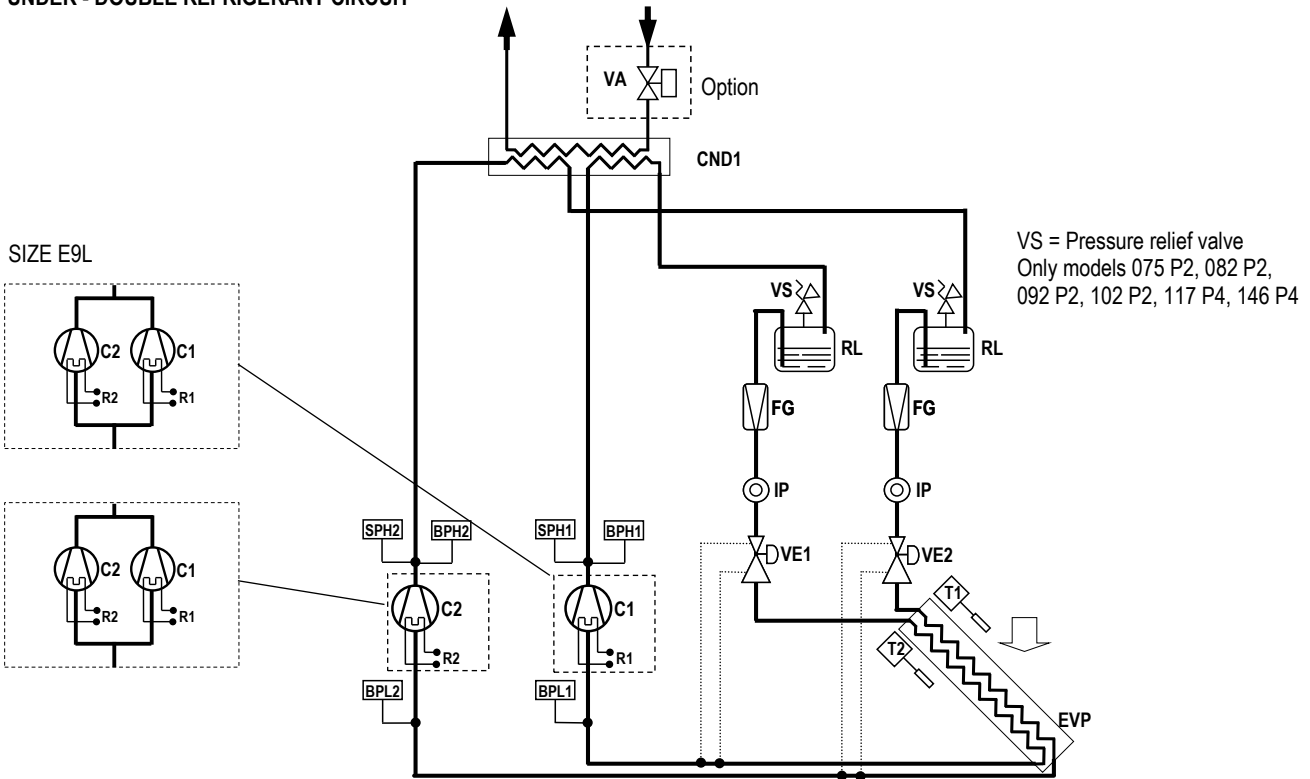

**OVER - DOUBLE REFRIGERANT CIRCUIT**

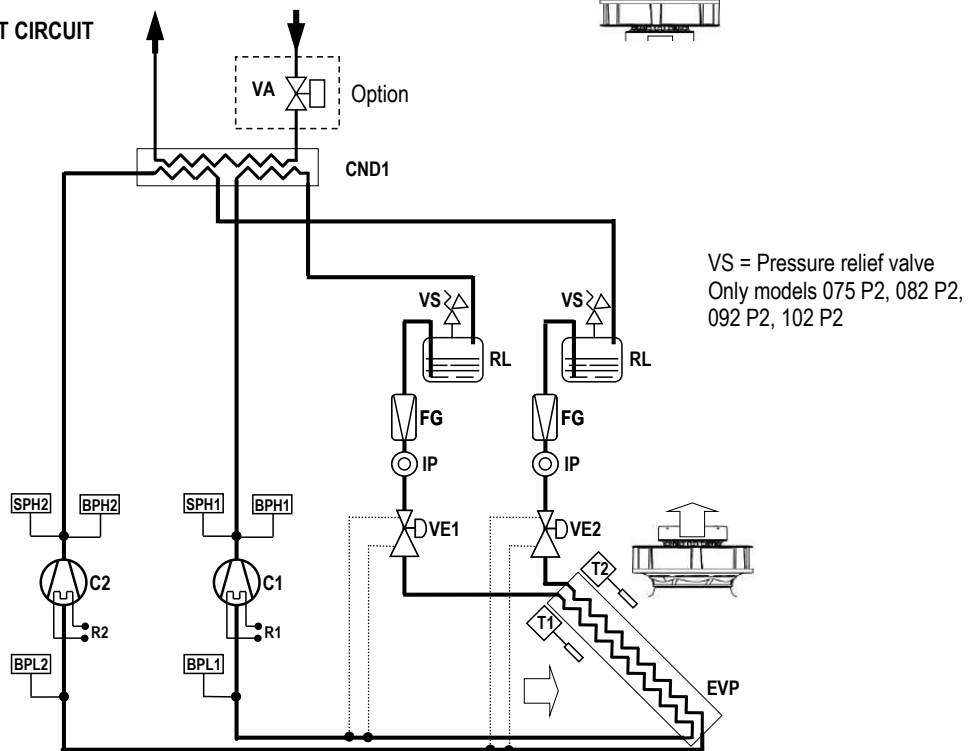

**LEGENDA**

C1...2 Compressor 1, 2  
 R1...2 Crankcase heater 1, 2  
 CND Condenser.  
 EVP Evaporator.  
 BPH High pressure transducer.

BPL Low pressure transducer.  
 SPH High pressure switch  
 VS Safety valve.  
 FG Refrigerant filter.

IP Sight glass.  
 VE Expansion valve.  
 T Temperature probes.  
 RL Liquid receiver  
 VA Motorized valve for condensing control

## PRESSURE RELIEF VALVE

The pressure relief valve of the refrigerant circuit is installed in the machines when required by Directive 2014/68/EU.  
The valve is installed on liquid receiver of each refrigerant circuit of the machine with the purpose to protect the circuit from overpressure.

Factory installed components	
Pressure relief valve on liquid receiver	
Model	[bar]
007 P1 S	---
009 P1 S	---
011 P1 S	---
014 P1 S	---
016 P1 S	---
020 P1 S	---
022 P1 S	---
026 P1 S	---
032 P1 S	---
037 P1 S	---
041 P1 S	45,0
045 P1 S	45,0
039 P2 D	---
048 P2 D	---
055 P2 D	---
062 P2 D	---
075 P2 D	45,0
082 P2 D	45,0
092 P2 D	45,0
102 P2 D	45,0
117 P4 D	45,0
146 P4 D	45,0

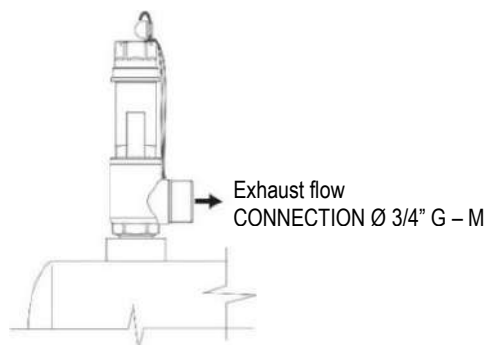

## WATER QUALITY OF THE HYDRAULIC CIRCUITS

The values shown in the table must be guaranteed during the entire life cycle of the machine.

	Description	Symbol	Range
1	Hydrogen Ions	pH	7.5 ÷ 9
2	Presence of calcium (Ca) and magnesium (Mg)	Hardness	4 ÷ 8.5 °D
3	Chlorine ions	Cl <sup>-</sup>	< 150 ppm
4	Iron Ions	Fe <sup>3+</sup>	< 0.5 ppm
5	Manganese Ions	Mn <sup>2+</sup>	< 0.05 ppm
6	Carbon dioxide	CO <sub>2</sub>	< 10 ppm
7	Hydrogen sulphide	H <sub>2</sub> S	< 50 ppb
8	Oxygen	O <sub>2</sub>	< 0.1 ppm
9	Chlorine	Cl <sub>2</sub>	< 0.5 ppm
10	Ammonia	NH <sub>3</sub>	< 0.5 ppm
11	Ratio between carbonates and sulphates	HCO <sub>3</sub> <sup>-</sup> /SO <sub>4</sub> <sup>2-</sup>	> 1
12	Sulphate ions	SO <sub>4</sub> <sup>-</sup>	< 100 ppm
13	Phosphate ions	PO <sub>4</sub> <sup>3-</sup>	< 2.0 ppm

where:  $1/1.78^{\circ}D = 1^{\circ}Fr$  with  $1^{\circ}Fr = 10 \text{ gr CaCO}_3 / \text{m}^3$

ppm = parts for millions

ppb = part for billion

Explanatory notes:

- ref.1: A greater concentration of hydrogen ions (pH) than 9 implies a high risk of deposits, whereas a lower pH than 7 implies a high risk of corrosion.
- ref.2: The hardness measures the amount of Ca and Mg carbonate dissolved in the water with a temperature lower than 100°C (temporary hardness). A high hardness implies a high risk of deposits.
- ref.3: The concentration of chloride ions with higher values than those indicated causes corrosion.
- ref. 4 - 5 - 8: The presence of iron and manganese ions and oxygen leads to corrosion.
- ref.6 - 7: Carbon dioxide and hydrogen sulphide are impurities that promote corrosion.
- ref.9: Usually in water from the waterworks it is a value of between 0.2 and 0.3 ppm. High values cause corrosion.
- ref.10: The presence of ammonia reinforces the oxidising power of oxygen
- ref.11: Below the value shown in the table, there is a risk of corrosion due to the trigger of galvanic currents between copper and other less noble metals.
- ref.12: The presence of sulphates ions triggers corrosion phenomenon.
- ref.13: The presence of phosphates ions triggers corrosion phenomenon.

It is necessary to carry out periodic checks, with withdrawals at different points of the hydraulic system. During the first year of operation, checks are recommended every 4 months which can be reduced every 6 months starting from the second year of operation.

### WARNING:

Values of the parameters outside the indicated ranges can lead to the formation of deposits and limescale and/or favour corrosive phenomena within the plant. For operating fluids other than water (mixtures of ethylene and propylene glycol) it is recommended to use specific inhibitors, designed to offer thermal stability within the operating temperature range and protection against corrosion. It is necessary that, in the presence of dirty and / or aggressive waters, an intermediate heat exchanger is installed upstream of the heat exchangers.

### ANTIFREEZE MIXTURES

In plants that are not adequately protected by heating cables, protect the hydraulic circuit with an anti-freeze mixture when the ambient air temperature can drop below 5°C.

Minimum ambient air temperature	°C	5	0	-5	-10	-15	-20	-25	-30
ETHYLENE GLYCOL (suggested % in weight)	%	0	12	20	30	35	40	45	50

Minimum ambient air temperature	°C	5	2	-3	-9	-13	-17	-23	-29
PROPYLENE GLYCOL (suggested % in weight)	%	0	10	20	30	35	40	45	50

The values are indicative and may significantly vary depending on the glycol manufacturer. Refer to your glycol supplier for detail.

The values consider a precautionary difference of 5°C between the minimum ambient air temperature and the freezing temperature of the mixture.

In the hydraulic circuit do not send fluids other than water or mixtures with ethylene / propylene glycol.

If other products are provided, in addition to mixtures of water and ethylene or propylene glycol, contact the Manufacturer to check the compatibility with the machine components.

## ACOUSTIC DATA

Acoustic data of the standard machine at full load working conditions.

### WARNING:

In a closed room the noise produced by a sound source reaches the listener in two different ways:

- Directly
- Reflected from the surrounding walls, floor, ceiling, from furniture.

With the same sound source, the noise produced in a closed room is greater than that produced outdoors. In fact, the sound pressure level generated by the source, must be added to the one reflected from the room. Also, the shape of the room affects the sound.

MODEL		007 P1 S	009 P1 S	011 P1 S	014 P1 S	016 P1 S	020 P1 S
SIZE		E1	E1	E1	E2	E2	E3
<b>SOUND LEVEL ISO 3744 (1)</b>							
On air delivery, Under	dB(A)	62,3	64,0	64,7	70,8	71,9	70,3
On air intake, Under	dB(A)	53,5	54,9	55,9	56,9	58,1	57,0
On front side, Under	dB(A)	44	46	47	48	49	48
On air delivery, Over	dB(A)	62,3	64,0	64,7	70,8	71,9	70,3
On air intake, Over (2)	dB(A)	50	50	52	54	55	55
On front side, Over (3)	dB(A)	39,5	40,8	41,8	47,1	48,1	46,7

MODEL		022 P1 S	026 P1 S	032 P1 S	037 P1 S	041 P1 S	045 P1 S
SIZE		E3	E3	E4L	E4L	E4L	E4L
<b>SOUND LEVEL ISO 3744 (1)</b>							
On air delivery, Under	dB(A)	71,8	72,8	78,1	81,1	78,9	78,9
On air intake, Under	dB(A)	58,9	59,2	64,2	67,1	66,4	66,4
On front side, Under	dB(A)	50	50	55	58	57	57
On air delivery, Over	dB(A)	71,8	72,8	78,1	81,1	78,9	78,9
On air intake, Over (2)	dB(A)	59	57	61	63	62	62
On front side, Over (3)	dB(A)	48,7	49,0	54,3	57,3	56,8	56,8

MODEL		039 P2 D	048 P2 D	055 P2 D	062 P2 D	075 P2 D	082 P2 D
SIZE		E5L	E5L	E6L	E6L	E7L	E7L
<b>SOUND LEVEL ISO 3744 (1)</b>							
On air delivery, Under	dB(A)	81,3	81,5	77,9	78,7	80,1	80,1
On air intake, Under	dB(A)	67,3	69,0	64,1	65,0	67,8	67,8
On front side, Under	dB(A)	58	60	55	56	58	58
On air delivery, Over	dB(A)	81,3	81,5	77,9	78,7	80,1	80,1
On air intake, Over (2)	dB(A)	63	64	61	62	64	64
On front side, Over (3)	dB(A)	57,6	59,4	54,1	55,0	58,1	58,1

MODEL		092 P2 D	102 P2 D	117 P4 D	146 P4 D
SIZE		E8L	E8L	E9L	E9L
<b>SOUND LEVEL ISO 3744 (1)</b>					
On air delivery, Under	dB(A)	82,5	82,5	83,4	83,4
On air intake, Under	dB(A)	70,1	70,1	70,9	70,9
On front side, Under	dB(A)	61	61	62	62
On air delivery, Over	dB(A)	82,5	82,5	--	--
On air intake, Over (2)	dB(A)	66	67	--	--
On front side, Over (3)	dB(A)	60,4	60,4	--	--

1. Noise pressure level at 1 meter in free field – ISO 3744
2. Air intake from the front
3. Air intake from the bottom

## ELECTRICAL DATA

Electrical data of the system at full load working conditions.

VERSION (1)		U / O	U / O	U / O	U / O	U / O	U / O
MODEL		007 P1 S	009 P1 S	011 P1 S	014 P1 S	016 P1 S	020 P1 S
SIZE		E1	E1	E1	E2	E2	E3
Power supply	V/ph/Hz	400/3+N/50	400/3+N/50	400/3+N/50	400/3+N/50	400/3+N/50	400/3+N/50
Maximum current input (FLA)	A	6,94	7,82	9,52	10,0	11,5	16,6

VERSION (1)		U / O	U / O	U / O	U / O	U / O	U / O
MODEL		022 P1 S	026 P1 S	032 P1 S	037 P1 S	041 P1 S	045 P1 S
SIZE		E3	E3	E4L	E4L	E4L	E4L
Power supply	V/ph/Hz	400/3+N/50	400/3+N/50	400/3+N/50	400/3+N/50	400/3+N/50	400/3+N/50
Maximum current input (FLA)	A	20,6	21,8	23,8	27,2	30,4	36,4

VERSION (1)		U / O	U / O	U / O	U / O	U / O	U / O
MODEL		039 P2 D	048 P2 D	055 P2 D	062 P2 D	075 P2 D	082 P2 D
SIZE		E5L	E5L	E6L	E6L	E7L	E7L
Power supply	V/ph/Hz	400/3+N/50	400/3+N/50	400/3+N/50	400/3+N/50	400/3+N/50	400/3+N/50
Maximum current input (FLA)	A	27,6	35,4	43,6	47,6	54,0	60,8

VERSION (1)		U / O	U / O	U	U
MODEL		092 P2 D	102 P2 D	117 P4 D	146 P4 D
SIZE		E8L	E8L	E9L	E9L
Power supply	V/ph/Hz	400/3+N/50	400/3+N/50	400/3+N/50	400/3+N/50
Maximum current input (FLA)	A	72,8	78,8	89,0	116

1. U = Under, downflow / O = Over, upflow

### WARNING:

The electric data indicated refer only to the indoor unit.

Optional accessory electric data are included within the dedicated chapters and must be added.

Please refer to ELCA WORLD selection program to calculate the electrical data of the air conditioner according to the requested optional accessories.



**MICROPROCESSOR CONTROL SYSTEM**



Controller



Keyboard and Display

The unit is equipped with the controller connected to a 6 keys keyboard with graphic display on which all information in English language or easily identifiable symbols are displayed.  
The controller disposes of a "flash" memory that preserves the information even in absence of power supply. Part of memory is dedicated to the registration of intervened events - up to 200 events.

**DISPLAY – KEYBOARD FUNCTIONS**

	ALARM	Alarm presence with red light. Push for alarm description. In case of more alarms scroll by UP / DOWN.
	PRG	Menu list, scrolled by UP/DOWN: <b>Unit; Set-point; In/Out; Clock; History; User; Service; Factory.</b> ENTER to execute.
	ESC	Home. Used to come back to the previous menu level or to the main screen.
	UP DOWN	Changes pages and values of sets. By pressing in HOME mask, the synoptic of the main controls is displayed.
	ENTER	Moving the cursor on adjustable Program(s) fields to confirm the changes. Press ENTER to get out the fields.

**DISPLAY - MAIN MASK**

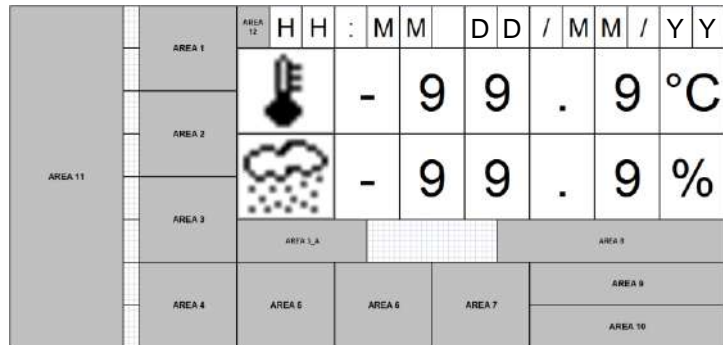

The main mask shows time, date, room temperature and humidity values (if the relative probe is present) and areas for displaying operating and alarm status with dedicated icons:

- Area 1: Status of the unit: on / off
- Area 2: Status detail
- Area 3: Type of event (only in case of an event)
- Area 3\_A: Code and type of event
- Area 4: Active cooling devices
- Area 5: Active free-cooling devices
- Area 6: Active humidity devices
- Area 7: Active heating devices
- Area 8: on / off parameters
- Area 9: BMS address
- Area 10: LAN address
- Area 11: Schematic representation of units
- Area 12: Active function presence icon

**CONNECTIVITY**

Through the optional serial port, the microprocessor control enables communication with the modern buildings BMS systems with the following protocols: MODBUS; LON; BACNET MS/TP RS485; BACNET OVER IP.

**PASSWORD**

- Level 1: On request of the End User. Allowing to reach USER menu
- Level 2: Asks to Service: Allowing to reach SERVICE menu
- Level 3: Asks to Service: Allowing to reach FACTORY menu
- No passwords request to enter: UNIT, SETPOINT, IN/OUT, CLOCK, HISTORY menu



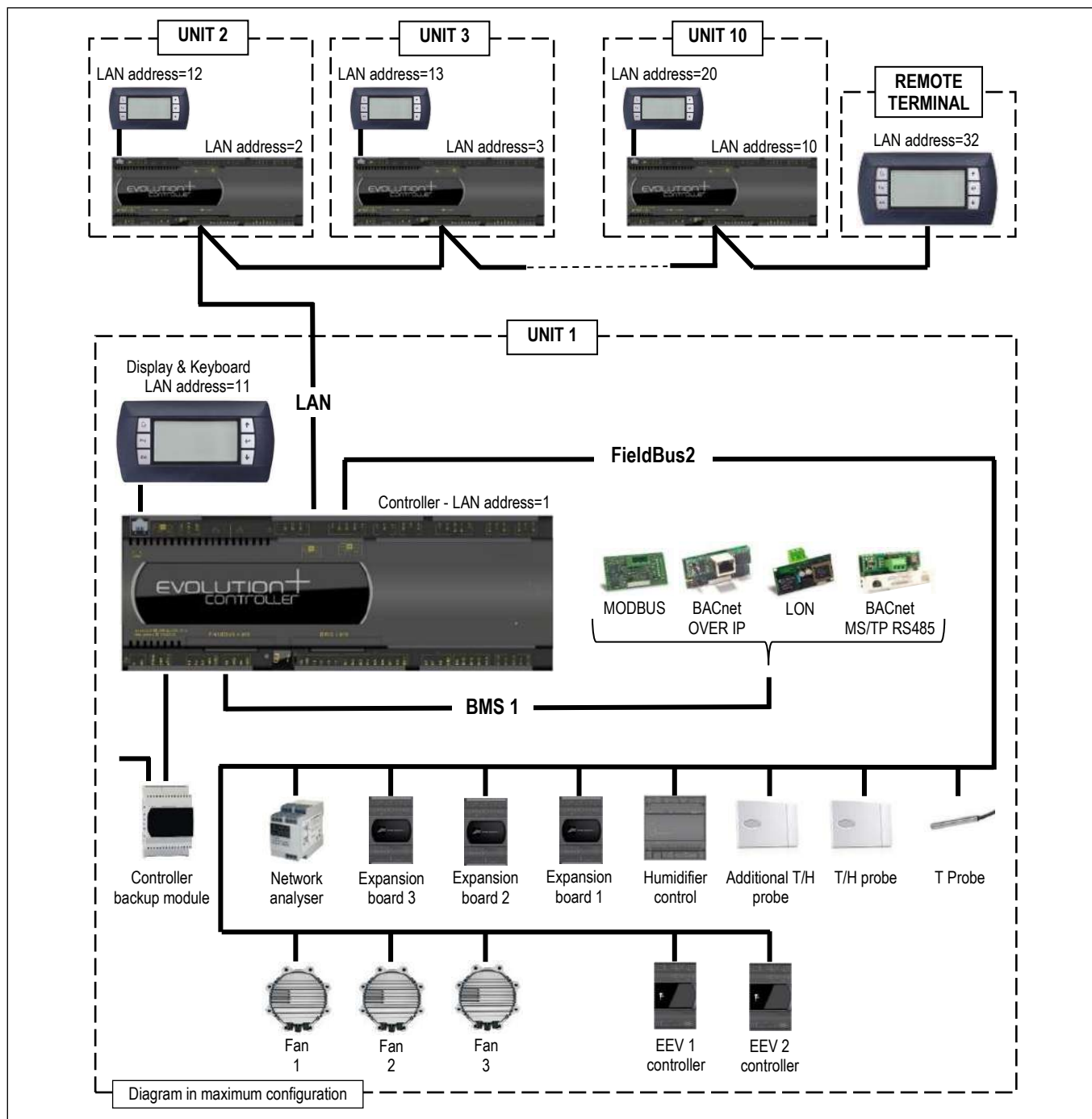

**LAN NETWORK**

The LAN is part of the control software and it is possible to connect up to 10 units. This type of connection allows to control the units in coherent way, moreover the units can be controlled and managed from a shared remote terminal.

**LAN ADDRESS LIST**

Unit #	1	2	3	4	5	6	7	8	9	10	Remote Terminal
Mother board address	1	2	3	4	5	6	7	8	9	10	--
Terminal address	11	12	13	14	15	16	17	18	19	20	32

The unit connection to the local network (LAN) allows to perform the following functions:

- Balancing the operating hours among the different units by rotating the reserve units (Stand-by)
- Turning on the reserve units in case other units should turn off due to an alarm, maintenance or power feed interruption
- Turning on reserve units to offset the excessive thermal load
- Checking up to 10 units with a single user terminal (shared user terminal)

### DEMAND LIMIT

Demand Limit function is part of the control software for machines with double refrigerant circuit. It allows to limit the absorbed current of the machine.  
The function must be activated and configured. A digital inlet on electrical panel connecting terminals allows the remote enabling of the function with an external signal without tension.  
The software allows to select the resources to disable (compressors, electric heaters,...).

### TEMPERATURE PROBE ON AIR RETURN / DELIVERY



Temperature probe installed on the air return and delivery.  
Temperature control and regulation function on air return.

### CLOGGED FILTERS SENSOR



The system includes a differential pressure switch installed in the electrical panel or in the front of the indoor unit and the plastic hoses for the relief of the pressure upstream and downstream the air filters.

Control range: 0.3 ... 4.0 mbar (30 ... 400 Pa)  
Differential for intervention: 0.15 mbar (15 Pa)

### FLOOD SENSOR



The system includes an electronic relay installed in the electrical panel of the machine and a water detector.  
The electrical connections for the probe and the alarm contact are present in the machine's terminal board.  
Sensor is supplied to be connected and installed at customer care.

**POSSIBLE AIR INTAKE FOR OVER VERSIONS**

**OVER VERSION - AIR INTAKE FROM THE BOTTOM**

Thanks to the particular basement design, it is possible to have the unit air intake from the bottom side. With this solution, it is necessary to foresee the optional blind frontal panels

**OVER VERSION - AIR INTAKE FROM THE BACK SIDE**

(Sizes E4L, E5L, E6L, E7L, E8L, E9L excluded)

It is possible to have the unit air intake from the back side.

Due to the limited size of the air intake, the air flow is limited to the 20% of the nominal one.

The air intake has to be made by Customer during installation.

In case the air intake is used for fresh air, it is necessary the temperature / humidity probe reposition in front of the heat exchanger, to allow for optimum reading of the values of temperature / humidity.

The electric cable of the probe has sufficient length for the repositioning.

**AIR INTAKE FROM THE BACK SIDE**

Back side view

**OVER**  
E1 – E2 – E3

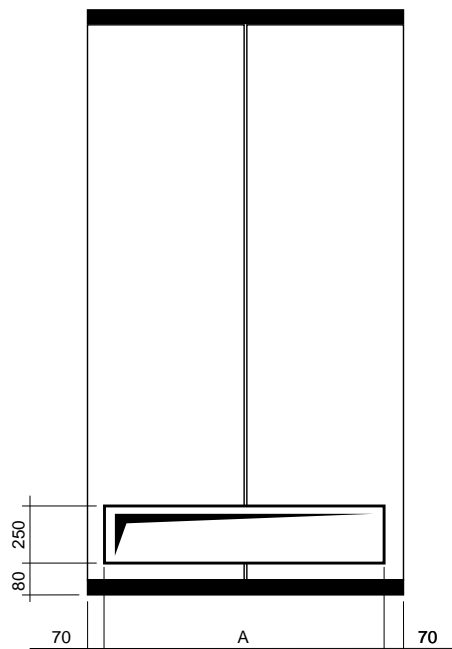

SIZE		E1	E2	E3
A	mm	510	645	945
Max air flow	m <sup>3</sup> /h	600	1000	1500

### REMOTE DRY COOLERS

Remote dry coolers for matching to air conditioners for IT Cooling.  
The constructive solutions allow high application flexibility.  
Horizontal air flow, from coil to fan.  
The series has an independent power supply from the indoor unit.  
Among the indoor unit and the dry cooler is necessary the electrical connection of the condensing proportional control signal and the alarms.

### BVE DC SERIES



BVE DC-A

**BVE DC-A:** Dry coolers equipped with axial fans and coil with copper tubes and aluminium fins.  
The machines are suitable for outdoor installation.

Equipped with AC axial fans.

The series is available in 3 versions:

- STD - No air flow and sound level reduction.
- LNO - Air flow reduction at 85% with consequent sound level reduction.
- ELN - Air flow reduction at 70% with further sound level reduction.

#### **IMPORTANT**

For further information about the units, please refer to "BVE DC" Data Book.

#### **WARNING:**

Please refer to ELCA WORLD selection program to calculate the technical data of the air conditioner according to the selected dry coolers in STD, LNO and ELN versions.

## OPTIONAL ACCESSORIES: P121 – FRONT AIR INTAKE+BOTTOM PANEL

Available for OVER units.  
The optional is not compatible with "P122 Bottom air intake+blind panels" for OVER units.  
With this accessory, it is possible a noise insulation of the machine base, when the machine is installed directly on floor as raised floor, wood floor etc.  
The accessory includes:

- Panel in galvanized steel sheet.
- Noise insulation with special soundproof material.

The bottom panel is supplied assembled inside the unit base and does not modify the unit dimensions.

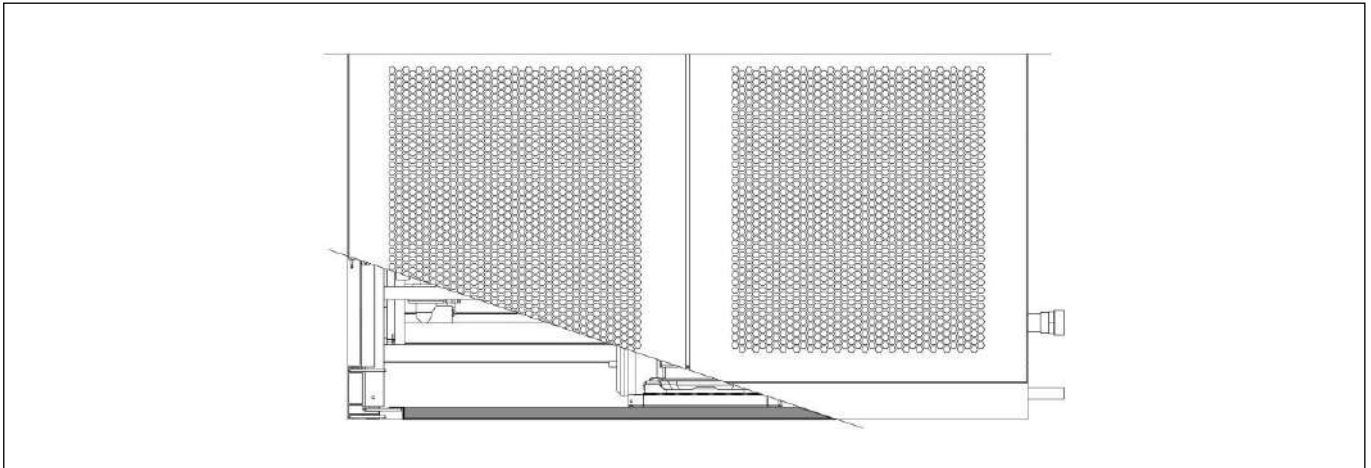

## OPTIONAL ACCESSORIES: P122 - BOTTOM AIR INTAKE+BLIND PANELS

Available for OVER units.  
The optional is not compatible with "P121 Front air intake+bottom panel" for OVER units.  
Thanks to the design of the basement is possible the air suction from the unit bottom. The air flow rate is the nominal one  
The accessory foresees the blind frontal panels.

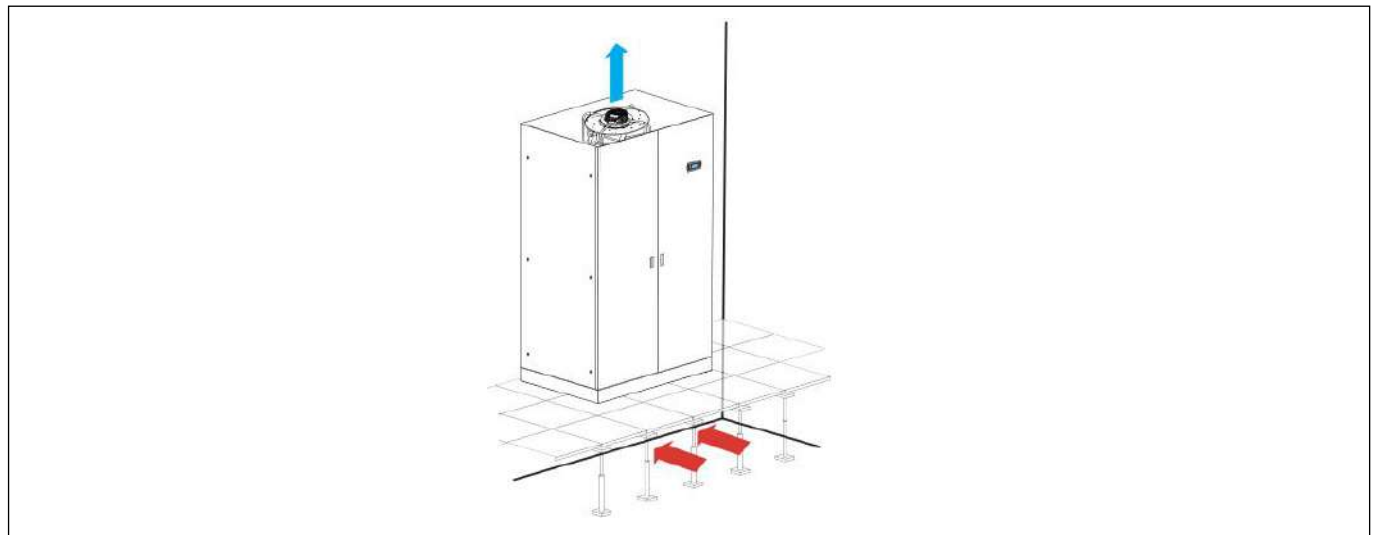

## OPTIONAL ACCESSORIES: 601 – SOLENOID VALVE ON LIQUID LINE



The accessory has the function of closing the liquid line, in the event of the machine stopping or blackout, avoiding the risk of liquid refrigerant migration into the evaporator.  
Recommended accessory for:

- Machines equipped with electronic expansion valve.

**OPTIONAL ACCESSORIES: P201 - CONDENSER + 2WAY BALL VALVE**

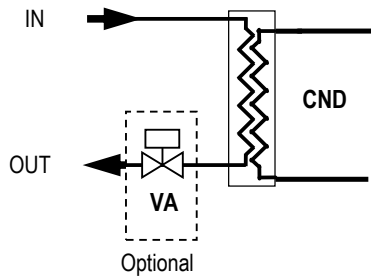

CND Condenser  
VA Condensing control valve

The optional accessory, installed on the condenser outlet side, includes a 2-way motorized valve for condensing control with 0÷10 VDC control actuator and emergency manual control. The water flow control is achieved through a **2-way modulating ball valve with equal percentage flow control** ensured by the integrated characterizing disc.

This type of valve offers the following series of benefits:

- Equal percentage flow control.
- No peaks initial flow.
- Excellent stability control thanks to the integrated characterizing disc.
- Excellent characteristic in partialisation.
- Stability in control.
- Maintenance free.
- Self-cleaning.

**CHARACTERISTICS OF THE 2-WAY BALL VALVE**

- Closing seal with leakage rate in Class A (EN 12266-1)
- Maximum fluid pressure  $P_s=1600\text{kPa}$
- Maximum closing pressure (Close-off)  $\Delta P_s=1400\text{kPa}$

The rotative actuator is controlled by a signal 0 ... 10VDC from the microprocessor controller. The actuator is equipped with an emergency button for manual operation and is maintenance-free.

**TECHNICAL DATA**

VERSION (1)	U / O	U / O	U / O	U / O	U / O	U / O
<b>MODEL</b>	<b>007 P1 S</b>	<b>009 P1 S</b>	<b>011 P1 S</b>	<b>014 P1 S</b>	<b>016 P1 S</b>	<b>020 P1 S</b>
<b>SIZE</b>	<b>E1</b>	<b>E1</b>	<b>E1</b>	<b>E2</b>	<b>E2</b>	<b>E3</b>
<b>CONDENSING CONTROL VALVE</b>						
$k_v$ – Flow coefficient	$\text{m}^3/\text{h}$	4,0	4,0	4,0	6,3	6,3
<b>VERSION (1)</b>	<b>U / O</b>	<b>U / O</b>	<b>U / O</b>	<b>U / O</b>	<b>U / O</b>	<b>U / O</b>
<b>MODEL</b>	<b>022 P1 S</b>	<b>026 P1 S</b>	<b>032 P1 S</b>	<b>037 P1 S</b>	<b>041 P1 S</b>	<b>045 P1 S</b>
<b>SIZE</b>	<b>E3</b>	<b>E3</b>	<b>E4L</b>	<b>E4L</b>	<b>E4L</b>	<b>E4L</b>
<b>CONDENSING CONTROL VALVE</b>						
$k_v$ – Flow coefficient	$\text{m}^3/\text{h}$	6,3	10,0	10,0	10,0	16,0
<b>VERSION (1)</b>	<b>U / O</b>	<b>U / O</b>	<b>U / O</b>	<b>U / O</b>	<b>U / O</b>	<b>U / O</b>
<b>MODEL</b>	<b>039 P2 D</b>	<b>048 P2 D</b>	<b>055 P2 D</b>	<b>062 P2 D</b>	<b>075 P2 D</b>	<b>082 P2 D</b>
<b>SIZE</b>	<b>E5L</b>	<b>E5L</b>	<b>E6L</b>	<b>E6L</b>	<b>E7L</b>	<b>E7L</b>
<b>CONDENSING CONTROL VALVE</b>						
$k_v$ – Flow coefficient	$\text{m}^3/\text{h}$	16,0	16,0	16,0	16,0	25,0
<b>VERSION (1)</b>	<b>U / O</b>	<b>U / O</b>	<b>U</b>	<b>U</b>		
<b>MODEL</b>	<b>092 P2 D</b>	<b>102 P2 D</b>	<b>117 P4 D</b>	<b>146 P4 D</b>		
<b>SIZE</b>	<b>E8L</b>	<b>E8L</b>	<b>E9L</b>	<b>E9L</b>		
<b>CONDENSING CONTROL VALVE</b>						
$k_v$ – Flow coefficient	$\text{m}^3/\text{h}$	25,0	25,0	40,0	40,0	

1. U = Under, downflow / O = Over, upflow

**IMPORTANT**

For further information, please refer to chapter "VALVE PRESSURE DROP CALCULATION AS FUNCTION OF WATER FLOW RATE"

**OPTIONAL ACCESSORIES: A548 - CONSTANT PREVALENCE**



The optional is a differential pressure sensor with a 0...20mA output signal. The device is installed in the machine.

The sensor is connected to the microprocessor control of the indoor unit and allows the control of:

**A548 - CONSTANT PREVALENCE**

The system controls the air pressure in the raised floor (Under version) or in the duct (Over version). Through the relief piping of the room pressure (low pressure side) and the air supply of the fan (high pressure side) the fan rotation speed is controlled to keep the air pressure constant. Pressure control range from 0 to 100 Pa.

**OPTIONAL ACCESSORIES: P091 - BACK-UP MODULE CONTROLLER**



The optional is installed within the electrical panel.  
 The optional is not available for size E1.  
 The system powers the microprocessor for a few minutes in the event of a power failure or voltage surges, preventing the re-boot of the controller.

**OPTIONAL ACCESSORIES: 383 – NUMBERED WIRINGS + UK REQUESTS**

The machine's electrical cables are all numbered for easy identification. For the power section it is possible to change the colour for the UK market.

CABLE	383 – COLOUR FOR UK
EARTH	YELLOW / GREEN
NEUTRAL	BLUE SKY
PHASE 1 (L1)	BROWN
PHASE 2 (L2)	BLACK
PHASE 3 (L3)	GREY
AUXILIARIES	RED

**OPTIONAL ACCESSORIES: 4181 – SERIAL CARD MODBUS**



The card is factory installed.  
 Consult the Interface Manual for all technical information.

**OPTIONAL ACCESSORIES: 4182 – SERIAL CARD LON**



The card is factory installed.  
 The manufacturer will supply the serial card and .NXE file and a .XIF files necessary for LonWorks technicians to configure the network.  
 The board is programmed by the technician in charge of the integration.  
 Consult the Interface Manual for all technical information.

**OPTIONAL ACCESSORIES: 4184 – SERIAL CARD BACNET MS/TP RS485**



The card is factory installed.  
 The supervision network is set up by the technicians developing the BACnet interface.  
 The Modbus protocol database is used for interfacing.  
 Consult the Interface Manual for all technical information.

**OPTIONAL ACCESSORIES: 4185 – SERIAL CARD BACNET OVER IP**



The card is factory installed.  
 The supervision network is set up by the technicians developing the BACnet interface. The Modbus protocol database is used for interfacing.  
 The manufacturer will supply the card and .MIB file necessary for technicians to configure the network.  
 The board is programmed by the technician in charge of the integration.  
 Consult the Interface Manual for all technical information and what is necessary for Internet connection to view and modify variables.



**OPTIONAL ACCESSORIES: A492 – WATER LEAKAGE DETECTOR + ADDITIONAL DETECTOR**



The system includes an electronic relay installed in the electrical panel of the indoor machine and 2 water detectors to be connected in series.  
The electrical connections for the probe and the alarm contact are present in the indoor machine's terminal board.  
The sensors are supplied to be connected and installed at customer care.

**OPTIONAL ACCESSORIES: A511 - SMOKE DETECTORS**

**OPTIONAL ACCESSORIES: A521 – FIRE DETECTORS**

Is possible to install one or both of the following sensors. Sensors are supplied in mounting kit. Installation within the room at customer care.



**A511 - SMOKE DETECTOR**

The device is supplied in mounting kit.  
The optical smoke detector senses the presence of combustion by-products (visible smoke) and activates an alarm.  
The operating principle is based on the light scattering technique (Tyndall effect).  
The device is in conformity to EN 54-7 standard.

Technical features:

Material	ABS	Relative humidity	<93% not-condensing
Power supply	12...28 Vdc	Index of protection	IP 20
Normal current	50µA 24 Vdc	Testing by magnet	Yes
Alarm current	25mA 24 Vdc	Relay	max. 1A 30Vdc
LED visibility	360° (double led)	Signal repeater	14mA 24 Vdc
Storage temperature	-10...+70°C	Covered area	40m² max.
Operating temperature	-10...+70°C	Shielded connection	Min. 0.5 mm²
Max. speed air	0.2 m/s	Colour	White

Supplied with unit to be connected and installed at customer care close to the unit.



**A521 - FIRE DETECTOR**

The device is supplied in mounting kit.  
The fire detector has been designed to identify temperatures at which fires may start. When the temperature exceeds the set threshold or when there is a rapid variation in temperature, the relay is activated to signal an alarm.  
The device is in conformity to EN 54-5 standard.

Technical features:

Material	ABS	Index of protection	IP 20
Power supply	12...28 Vdc	Testing by magnet	Yes
Normal current	50µA 24 Vdc	Relay	max. 1A 30Vdc
Alarm current	25mA 24 Vdc	Signal repeater	14mA - 24 Vdc
LED visibility	360° (double LED)	Alarm temperature	62°C
Storage temperature	-10...+70°C	Covered area	40m² max.
Operating temperature	-10...+70°C	Shielded connection	Min. 0.5 mm²
Relative humidity	<93% non-condensing	Colour	White

Supplied with unit to be connected and installed at customer care close to the unit.

**OPTIONAL ACCESSORIES: P141 – ANALOGUE SET-POINT COMPENSATION**

Analogue set point compensation according to an external analogue signal at Customer care.  
The microprocessor control, through the additional module "expansion card", can manage a compensation signal of the return air setpoint by analogue input (0...1V; 0...5V; 0.5...4.5V; 4...20mA; 0...20mA). The compensation curve allows to assign a temperature setpoint offset respectively to the minimum and maximum signal managed by the input.

**OPTIONAL ACCESSORIES: P181 – NETWORK ANALYZER**  
**OPTIONAL ACCESSORIES: P182 – NETWORK ANALYZER+OPTIONAL**  
**OPTIONAL ACCESSORIES: P183 – KIT NETWORK ANALYZER**  
**OPTIONAL ACCESSORIES: P184 – KIT NETWORK ANALYZER+OPTIONAL**



INTERNAL installation



EXTERNAL installation

This device provides continuous measurement of power consumption, monitoring current, voltage and power. These values are sent to unit microprocessor via RS485 serial cable, as shown on the unit wiring diagram. The displayed variables are:

- Phase to phase voltage, only for three-phase units;
- Phase voltage (phase-neutral);
- Phase current;
- Neutral current only for three-phase units;
- Active phase power, only for three-phase units;
- Total active power;
- Active energy;
- Hour counts

**INSTALLATION**

Frame	Power Supply	Installation	Code
E1	400/3+N/50	EXTERNAL to the unit, supplied in kit	P183 / P184 (*)
E2	400/3+N/50	EXTERNAL to the unit, supplied in kit	P183 / P184 (*)
E3	400/3+N/50	EXTERNAL to the unit, supplied in kit	P183 / P184 (*)
E4L	400/3+N/50	INTERNAL (on unit electrical panel)	P181 / P182 (*)
E5L	400/3+N/50	INTERNAL (on unit electrical panel)	P181 / P182 (*)
E6L	400/3+N/50	INTERNAL (on unit electrical panel)	P181 / P182 (*)
E7L	400/3+N/50	INTERNAL (on unit electrical panel)	P181 / P182 (*)
E8L	400/3+N/50	INTERNAL (on unit electrical panel)	P181 / P182 (*)
E9L	400/3+N/50	INTERNAL (on unit electrical panel)	P181 / P182 (*)

(\*) P182, P184 for units with optional (with electric heaters and/or humidifier)

**INTERNAL INSTALLATION**

The optional is installed within the electrical box downstream the main switch with door safety lock and includes:

- Network transducer;
- Current transformers, one for each power supply phase cable.

**MOUNTING KIT**

The optional is supplied in box for external installation to the machine with the dimensions showed in the figure below, and includes:

- Main switch with door lock safety;
- Fuse;
- Network transducer;
- Current transformers, one for each power supply phase cable;
- Terminals.

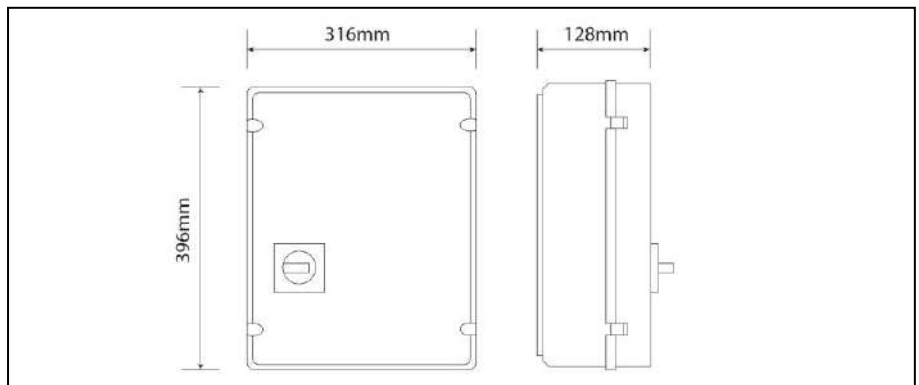

**OPTIONAL ACCESSORIES: A812 – FREE-COOLING DIRECT CONTROL**

Preparation of the machine and the electrical panel for the direct free-cooling system "P034 Intake free-cooling plenum "

## OPTIONAL ACCESSORIES: P131 – HOT WATER COIL+2WAY VALVE



The optional accessory is factory installed and don't modify the overall dimensions of the unit. Hot water heating system installed downstream the main cooling coil.

Components:

- Heat exchanger coil with internally corrugated copper tubes and high efficiency aluminium fins, specifically developed to provide high heat transfer and lower pressure drops.
- 2-way motorized valve for water flow regulation with 0÷10 VDC control actuator and emergency manual control.
- Temperature probe on water inlet.
- Frame in galvanized steel.

The hot water heating coil can be installed in combination with the "A432 electric heater". The operation is alternate with priority to the hot water heating coil.

For the water quality of the heating circuit, please refer to the chapter "WATER QUALITY OF THE HYDRAULIC CIRCUITS".

### TECHNICAL DATA

VERSION (1)		U / O	U / O	U / O	U / O	U / O	U / O
MODEL		007 P1 S	009 P1 S	011 P1 S	014 P1 S	016 P1 S	020 P1 S
SIZE		E1	E1	E1	E2	E2	E3
THERMAL CAPACITY (2)	kW	22,9	24,2	24,8	34,9	36,0	47,0
<b>HEATING COIL</b>							
Water flow rate (2)	m <sup>3</sup> /h	2,01	2,12	2,17	3,06	3,16	4,12
dP coil + valve (2)	kPa	23,8	25,6	26,6	25,2	26,3	24,8
Water volume	l	2,6	2,6	2,6	2,6	2,6	3,9
NET WEIGHT (3)	kg	15	15	15	18	18	25
<b>HYDRAULIC CONNECTIONS</b>							
WATER INLET / OUTLET ISO 7/1 - R	Ø	3/4"	3/4"	3/4"	3/4"	3/4"	1"

VERSION (1)		U / O	U / O	U / O	U / O	U / O	U / O
MODEL		022 P1 S	026 P1 S	032 P1 S	037 P1 S	041 P1 S	045 P1 S
SIZE		E3	E3	E4L	E4L	E4L	E4L
THERMAL CAPACITY (2)	kW	49,2	50,7	76,3	83,9	88,3	88,3
<b>HEATING COIL</b>							
Water flow rate (2)	m <sup>3</sup> /h	4,31	4,45	6,69	7,36	7,74	7,74
dP coil + valve (2)	kPa	26,4	27,5	9,29	10,4	11,1	11,1
Water volume	l	3,9	3,9	6,9	6,9	6,9	6,9
NET WEIGHT (3)	kg	25	25	35	35	35	35
<b>HYDRAULIC CONNECTIONS</b>							
WATER INLET / OUTLET ISO 7/1 - R	Ø	1"	1"	1+1/4"	1+1/4"	1+1/4"	1+1/4"

VERSION (1)		U / O	U / O	U / O	U / O	U / O	U / O
MODEL		039 P2 D	048 P2 D	055 P2 D	062 P2 D	075 P2 D	082 P2 D
SIZE		E5L	E5L	E6L	E6L	E7L	E7L
THERMAL CAPACITY (2)	kW	96,6	103	130	134	155	155
<b>HEATING COIL</b>							
Water flow rate (2)	m <sup>3</sup> /h	8,47	9,01	11,4	11,7	13,6	13,6
dP coil + valve (2)	kPa	19,2	21,1	35	36,3	6,94	6,94
Water volume	l	9,1	9,1	10,6	10,6	12,3	12,3
NET WEIGHT (3)	kg	42	42	50	50	57	57
<b>HYDRAULIC CONNECTIONS</b>							
WATER INLET / OUTLET ISO 7/1 - R	Ø	1+1/2"	1+1/2"	1+1/2"	1+1/2"	2"	2"

1. U = Under, downflow / O = Over, upflow

2. Characteristics referred to entering air at 20°C-50%UR with hot water temperature 70/60°C - 0% glycol.

3. Value to be added to the weight of the standard unit. Does not include the weight of the water content.

## TECHNICAL DATA

VERSION (1)		U / O	U / O	U	U
MODEL		092 P2 D	102 P2 D	117 P4 D	146 P4 D
SIZE		E8L	E8L	E9L	E9L
THERMAL CAPACITY (2)	kW	175	175	242	242
<b>HEATING COIL</b>					
Water flow rate (2)	m <sup>3</sup> /h	15,4	15,4	21,2	21,2
dP coil + valve (2)	kPa	9,62	9,62	21,0	21,0
Water volume	l	14,2	14,2	16,9	16,9
NET WEIGHT (3)	kg	65	65	75	75
<b>HYDRAULIC CONNECTIONS</b>					
WATER INLET / OUTLET	ISO 7/1 - R Ø	2"	2"	2"	2"

1. U = Under, downflow / O = Over, upflow
2. Characteristics referred to entering air at 20°C-50%UR with hot water temperature 70-60°C - 0% glycol.
3. Value to be added to the weight of the standard unit. Does not include the weight of the water content.

## 2-WAY BALL VALVE FOR HOT WATER FLOW CONTROL



The water flow control in the finned coil is achieved through a **2-way modulating ball valve with equal percentage flow control** ensured by the integrated characterizing disc.

This type of valve offers the following series of benefits:

- Equal percentage flow control.
- No peaks initial flow.
- Excellent stability control thanks to the integrated characterizing disc.
- Excellent characteristic in partialisation.
- Stability in control.
- Maintenance free.
- Self-cleaning.

### CHARACTERISTICS OF THE 2-WAY BALL VALVE

- Closing seal with leakage rate in Class A (EN 12266-1)
- Maximum fluid pressure  $P_s=1600\text{kPa}$
- Maximum closing pressure (Close-off)  $\Delta P_s=1400\text{kPa}$

The rotative actuator is controlled by a signal 0 ... 10VDC from the microprocessor controller. The actuator is equipped with an emergency button for manual operation and is maintenance-free.

HOT WATER HEATING HYDRAULIC / REFRIGERANT CIRCUIT

UNDER - SINGLE REFRIGERANT CIRCUIT

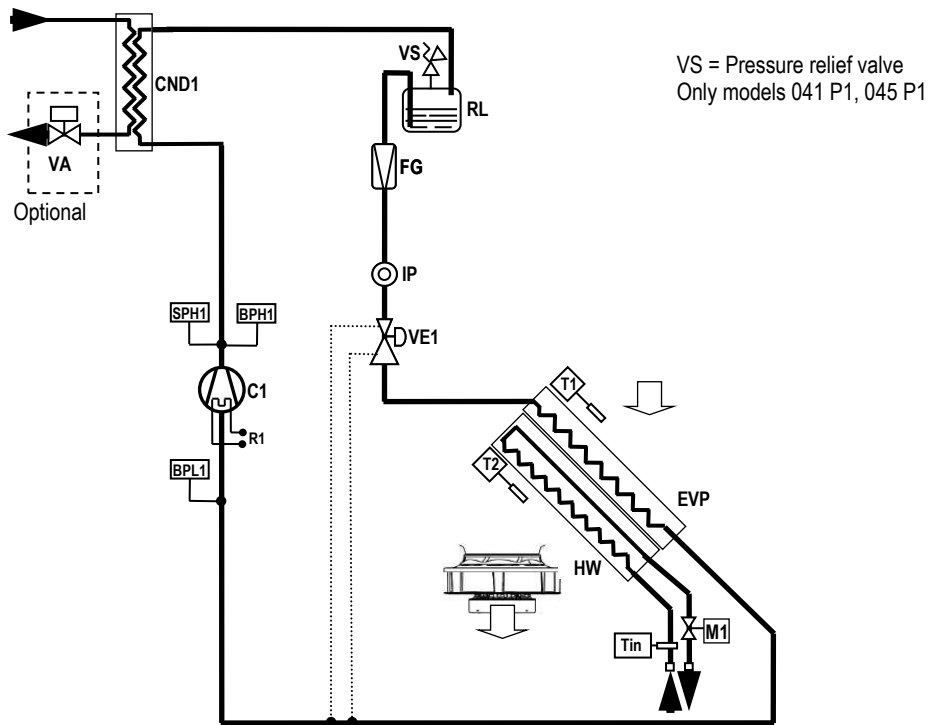

OVER - SINGLE REFRIGERANT CIRCUIT

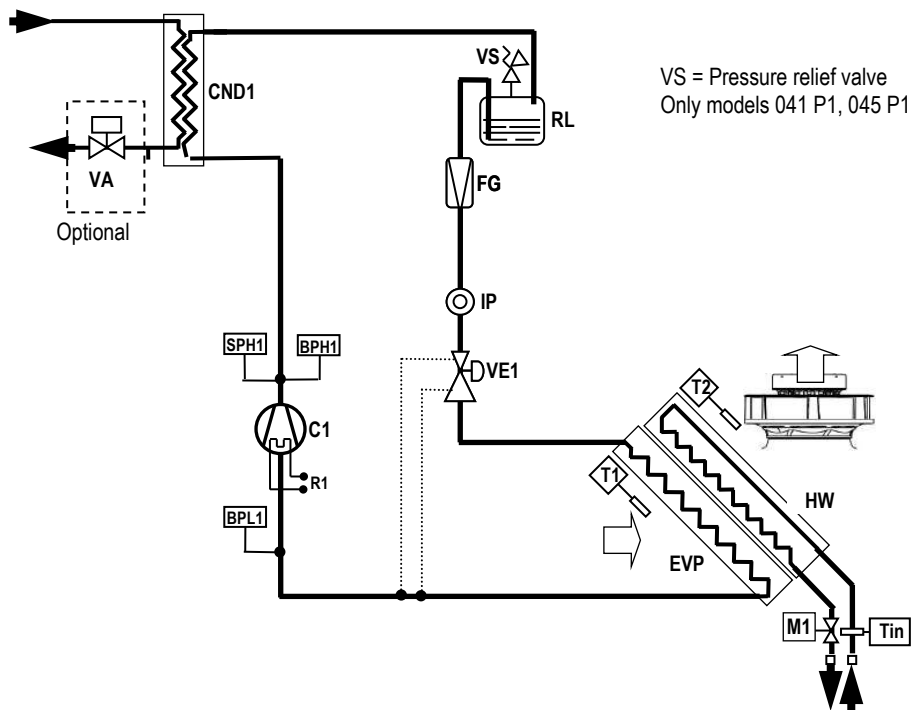

LEGENDA

C1	Compressor	BPH	High pressure transducer.	IP	Sight glass.
R1	Crankcase heater	BPL	Low pressure transducer.	VE	Expansion valve.
CND	Condenser.	SPH	High pressure switch	T	Temperature probes.
EVP	Evaporator	M1	Hot water 2-way valve	RU	Valves
HW	Hot water coil	VS	Safety valve.	RL	Liquid receiver
		FG	Refrigerant filter.		

HOT WATER HEATING HYDRAULIC / REFRIGERANT CIRCUIT

UNDER - DOUBLE REFRIGERANT CIRCUIT

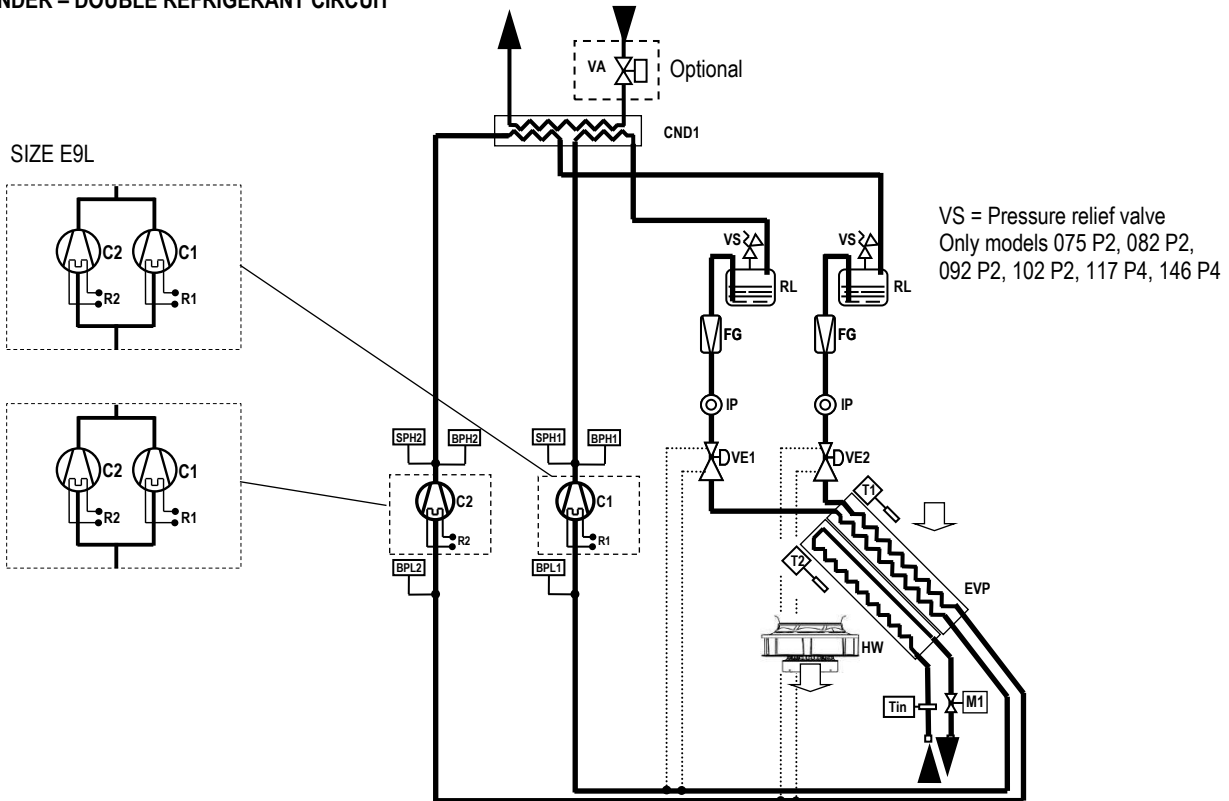

OVER - DOUBLE REFRIGERANT CIRCUIT

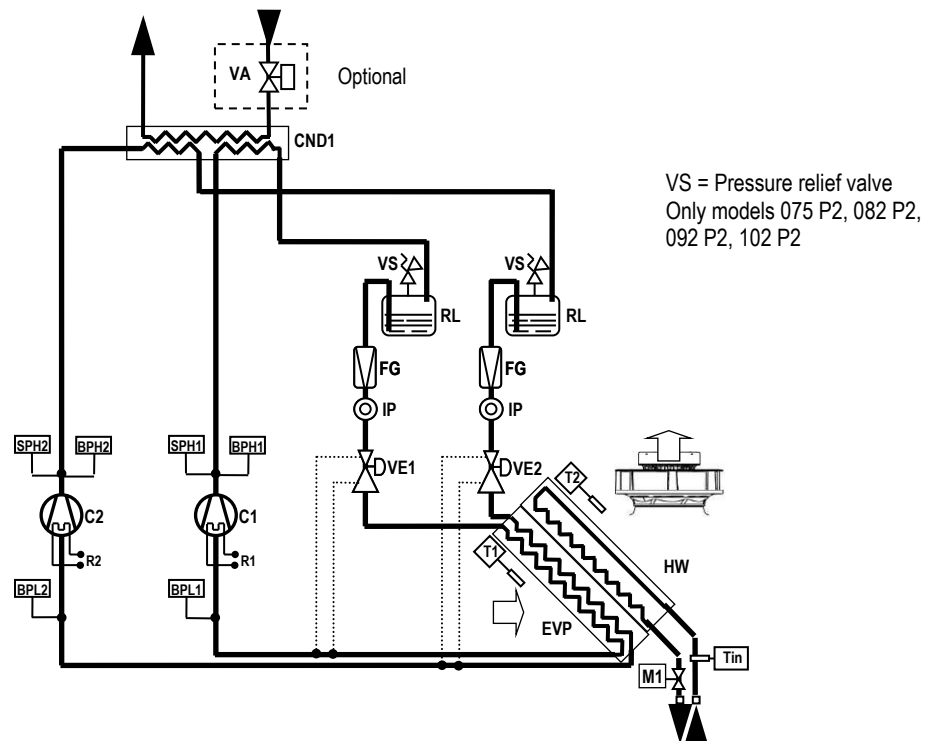

LEGENDA

- |        |                       |     |                           |    |                     |
|--------|-----------------------|-----|---------------------------|----|---------------------|
| C1...2 | Compressor 1, 2       | BPH | High pressure transducer. | IP | Sight glass.        |
| R1...2 | Crankcase heater 1, 2 | BPL | Low pressure transducer.  | VE | Expansion valve.    |
| CND    | Condenser.            | SPH | High pressure switch      | T  | Temperature probes. |
| EVP    | Evaporator            | M1  | Hot water 2-way valve     | RU | Valves              |
| HW     | Hot water coil        | VS  | Safety valve.             | RL | Liquid receiver     |
|        |                       | FG  | Refrigerant filter.       |    |                     |

**OPTIONAL ACCESSORIES: A431 – ELECTRIC HEATERS**

**OPTIONAL ACCESSORIES: A432 – EXTRA POWER ELECTRIC HEATERS**



**A431 –ELECTRIC HEATERS**

Electric heater consisting of finned aluminium elements, ensuring low surface temperature and deleting the air ionization problems. The optional is installed downstream the main cooling coil.

In electric heaters with three working steps the activation is binary type.

Components:

- Electric heater in aluminium armoured elements with integral fins
- Electrical control
- Safety thermostat.

The electric heater can be installed in combination with the “P131 hot water coil + 2-way valve”. The operation is alternate with priority to the hot water heating coil.

**TECHNICAL DATA**

VERSION (1)		U / O	U / O	U / O	U / O	U / O	U / O
MODEL		007 P1 S	009 P1 S	011 P1 S	014 P1 S	016 P1 S	020 P1 S
SIZE		E1	E1	E1	E2	E2	E3
<b>THERMAL CAPACITY</b>	<b>kW</b>	5,1	5,1	5,1	5,1	5,1	6,0
Absorbed current (OA)	A	7,4	7,4	7,4	7,4	7,4	8,7
First working step	kW	5,1	5,1	5,1	5,1	5,1	3,0
Second working step	kW	--	--	--	--	--	3,0+3,0
Third working step	kW	--	--	--	--	--	--
<b>NET WEIGHT (2)</b>	<b>kg</b>	4	4	4	4	4	7

VERSION (1)		U / O	U / O	U / O	U / O	U / O	U / O
MODEL		022 P1 S	026 P1 S	032 P1 S	037 P1 S	041 P1 S	045 P1 S
SIZE		E3	E3	E4L	E4L	E4L	E4L
<b>THERMAL CAPACITY</b>	<b>kW</b>	6,0	6,0	9,0	9,0	9,0	9,0
Absorbed current (OA)	A	8,7	8,7	13,0	13,0	13,0	13,0
First working step	kW	3,0	3,0	3,0	3,0	3,0	3,0
Second working step	kW	3,0+3,0	3,0+3,0	6,0	6,0	6,0	6,0
Third working step	kW	--	--	3,0+6,0	3,0+6,0	3,0+6,0	3,0+6,0
<b>NET WEIGHT (2)</b>	<b>kg</b>	7	7	9,5	9,5	9,5	9,5

VERSION (1)		U / O	U / O	U / O	U / O	U / O	U / O
MODEL		039 P2 D	048 P2 D	055 P2 D	062 P2 D	075 P2 D	082 P2 D
SIZE		E5L	E5L	E6L	E6L	E7L	E7L
<b>THERMAL CAPACITY</b>	<b>kW</b>	13,5	13,5	13,5	13,5	13,5	13,5
Absorbed current (OA)	A	19,5	19,5	19,5	19,5	19,5	19,5
First working step	kW	4,5	4,5	4,5	4,5	4,5	4,5
Second working step	kW	9,0	9,0	9,0	9,0	9,0	9,0
Third working step	kW	4,5+9,0	4,5+9,0	4,5+9,0	4,5+9,0	4,5+9,0	4,5+9,0
<b>NET WEIGHT (2)</b>	<b>kg</b>	10	10	9,5	9,5	9,5	9,5

VERSION (1)		U / O	U / O	U	U
MODEL		092 P2 D	102 P2 D	117 P4 D	146 P4 D
SIZE		E8L	E8L	E9L	E9L
<b>THERMAL CAPACITY</b>	<b>kW</b>	18,0	18,0	18,0	18,0
Absorbed current (OA)	A	26,0	26,0	26,0	26,0
First working step	kW	4,5	4,5	4,5	4,5
Second working step	kW	13,5	13,5	13,5	13,5
Third working step	kW	4,5+13,5	4,5+13,5	4,5+13,5	4,5+13,5
<b>NET WEIGHT (2)</b>	<b>kg</b>	11	11	11	11

1. U = Under, downflow / O = Over, upflow
2. Value to be added to the weight of the standard unit.

## A432 - EXTRA POWER ELECTRIC HEATERS

The optional is not available for sizes E1, E2.

The components are the same of the standard accessory

It is not possible to combine the extra power electric heaters with the "P131 hot water coil + 2-way valve"

### TECHNICAL DATA

VERSION (1)		U / O	U / O	U / O	U / O	U / O	U / O
MODEL		007 P1 S	009 P1 S	011 P1 S	014 P1 S	016 P1 S	020 P1 S
SIZE		E1	E1	E1	E2	E2	E3
<b>THERMAL CAPACITY</b>	<b>kW</b>	--	--	--	--	--	<b>9,0</b>
Absorbed current (OA)	A	--	--	--	--	--	13,0
First working step	kW	--	--	--	--	--	4,5
Second working step	kW	--	--	--	--	--	4,5+4,5
Third working step	kW	--	--	--	--	--	--
<b>NET WEIGHT (2)</b>	<b>kg</b>	--	--	--	--	--	<b>7</b>

VERSION (1)		U / O	U / O	U / O	U / O	U / O	U / O
MODEL		022 P1 S	026 P1 S	032 P1 S	037 P1 S	041 P1 S	045 P1 S
SIZE		E3	E3	E4L	E4L	E4L	E4L
<b>THERMAL CAPACITY</b>	<b>kW</b>	<b>9,0</b>	<b>9,0</b>	<b>13,5</b>	<b>13,5</b>	<b>13,5</b>	<b>13,5</b>
Absorbed current (OA)	A	13,0	13,0	19,5	19,5	19,5	19,5
First working step	kW	4,5	4,5	4,5	4,5	4,5	4,5
Second working step	kW	4,5+4,5	4,5+4,5	9,0	9,0	9,0	9,0
Third working step	kW	--	--	4,5+9,0	4,5+9,0	4,5+9,0	4,5+9,0
<b>NET WEIGHT (2)</b>	<b>kg</b>	<b>7</b>	<b>7</b>	<b>9,5</b>	<b>9,5</b>	<b>9,5</b>	<b>9,5</b>

VERSION (1)		U / O	U / O	U / O	U / O	U / O	U / O
MODEL		039 P2 D	048 P2 D	055 P2 D	062 P2 D	075 P2 D	082 P2 D
SIZE		E5L	E5L	E6L	E6L	E7L	E7L
<b>THERMAL CAPACITY</b>	<b>kW</b>	<b>18,0</b>	<b>18,0</b>	<b>18,0</b>	<b>18,0</b>	<b>18,0</b>	<b>18,0</b>
Absorbed current (OA)	A	26,0	26,0	26,0	26,0	26,0	26,0
First working step	kW	4,5	4,5	4,5	4,5	4,5	4,5
Second working step	kW	13,5	13,5	13,5	13,5	13,5	13,5
Third working step	kW	4,5+13,5	4,5+13,5	4,5+13,5	4,5+13,5	4,5+13,5	4,5+13,5
<b>NET WEIGHT (2)</b>	<b>kg</b>	<b>12</b>	<b>12</b>	<b>11,5</b>	<b>11,5</b>	<b>11,5</b>	<b>11,5</b>

VERSION (1)		U / O	U / O	U	U
MODEL		092 P2 D	102 P2 D	117 P4 D	146 P4 D
SIZE		E8L	E8L	E9L	E9L
<b>THERMAL CAPACITY</b>	<b>kW</b>	<b>27,0</b>	<b>27,0</b>	<b>27,0</b>	<b>27,0</b>
Absorbed current (OA)	A	39,0	39,0	39,0	39,0
First working step	kW	9,0	9,0	9,0	9,0
Second working step	kW	18,0	18,0	18,0	18,0
Third working step	kW	9,0+18,0	9,0+18,0	9,0+18,0	9,0+18,0
<b>NET WEIGHT (2)</b>	<b>kg</b>	<b>14,4</b>	<b>14,5</b>	<b>14,5</b>	<b>14,5</b>

1. U = Under, downflow / O = Over, upflow
2. Value to be added to the weight of the standard unit.



**OPTIONAL ACCESSORIES: 4301 – STEAM HUMIDIFIER 3KG/H**  
**OPTIONAL ACCESSORIES: 4303 – STEAM HUMIDIFIER 8KG/H**  
**OPTIONAL ACCESSORIES: 4305 – STEAM HUMIDIFIER 15KG/H**

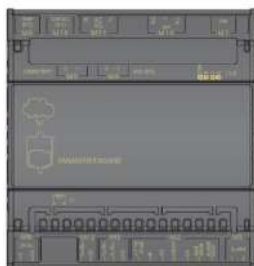

Humidifier control board

Modulating steam humidifier with immersed electrodes fitted with safety and running accessories. The optional includes the control board.

The optional requires mandatory accessory "P161 T/rH air intake sensor". The optional is factory installed and requires only water filling connection.

**Humidifier water charge and discharge pipes are not supplied.**

It is recommended to install a filter and a shut-off valve on the pipe to the water inlet.

This humidifier produces non pressurized steam by electrodes immersed in the water inside the cylinder: they bring the electric phase in the water that works as an electrical resistance and overheats. The steam so produced is distributed with dedicated distributors and used for ambient humidification or for industrial processes.

**CHARACTERISTICS OF THE SUPPLY WATER**

The quality of the used water influences the evaporation process, so the humidifier can be fed with **not-treated water, only when potable and non-demineralised.**

**LIMIT VALUES**

		Min	Max
Hydrogen ions	pH	7	8,5
Specific conductivity at 20°C	$\sigma_{R, 20^\circ C}$ $\mu S/cm$	350	750
Total dissolved solids	TDS mg/l	(1)	(1)
Dry residue at 180°C	R <sub>180</sub> mg/l	(1)	(1)
Total hardness	TH mg/l CaCO <sub>3</sub>	100 (2)	400
Temporary hardness	mg/l CaCO <sub>3</sub>	60 (3)	300
Iron + Manganese	mg/l Fe + Mn	0	0,2
Chlorides	ppm Cl	0	30
Silica	mg/l SiO <sub>2</sub>	0	20
Residual chlorine	mg/l Cl <sup>-</sup>	0	0,2
Calcium sulphate	mg/l CaSO <sub>4</sub>	0	100
Metallic impurities	mg/l	0	0
Solvents, diluents, soaps, lubricants	mg/l	0	0

(1) Values depending on specific conductivity; in general: TDS  $\cong$  0,93 \*  $\sigma_{R, 20^\circ C}$ ; R<sub>180</sub>  $\cong$  0,65 \*  $\sigma_{R, 20^\circ C}$

(2) Not lower than 200% of the chloride content in mg/l di Cl<sup>-</sup>

(3) Not lower than 300% of the chloride content in mg/l di Cl<sup>-</sup>

**WARNING:**

- Use only with drinking water.
- There is no reliable relationship between hardness and water conductivity
- Do not treat water with softeners! This could cause corrosion of the electrodes or the formation of foam, leading to potential operating problems or failures.
- Do not add disinfectants or corrosion inhibitors to water, as these substances are potentially irritant.
- Is absolutely forbidden to use well water, industrial water or water drawn from cooling circuits; in general, avoid using potentially contaminated water, either from a chemical or bacteriological point of view.

**TECHNICAL DATA**

VERSION (1)		U / O	U / O	U / O	U / O	U / O	U / O
MODEL		007 P1 S	009 P1 S	011 P1 S	014 P1 S	016 P1 S	020 P1 S
SIZE		E1	E1	E1	E2	E2	E3
<b>VAPOUR PRODUCTION</b>	<b>kg/h</b>	<b>3,0</b>	<b>3,0</b>	<b>3,0</b>	<b>3,0</b>	<b>3,0</b>	<b>3,0</b>
Power input	kW	2,3	2,3	2,3	2,3	2,3	2,3
Absorbed current (OA)	A	3,2	3,2	3,2	3,2	3,2	3,2
Max absorbed current (FLA)	A	4,5	4,5	4,5	4,5	4,5	4,5
Water content	l	3,9	3,9	3,9	3,9	3,9	3,9
Max water supply pressure	Bar	1÷8	1÷8	1÷8	1÷8	1÷8	1÷8
<b>NET WEIGHT (2)</b>	<b>kg</b>	<b>4</b>	<b>4</b>	<b>4</b>	<b>5</b>	<b>5</b>	<b>6</b>
<b>HYDRAULIC CONNECTION</b>							
WATER INLET - ISO 228/1 – G F	Ø	3/4"	3/4"	3/4"	3/4"	3/4"	3/4"
WATER INLET - ISO 228/1 – G M	Ø	-	-	-	-	-	-
WATER OUTLET - internal diameter	Ø mm	19	19	19	19	19	19
WATER OUTLET - external diameter	Ø mm	-	-	-	-	-	-

1. U = Under, downflow / O = Over, upflow

2. Value to be added to the weight of the standard unit. Does not include the weight of the water content.

## TECHNICAL DATA

VERSION (1)		U / O	U / O	U / O	U / O	U / O	U / O
MODEL		022 P1 S	026 P1 S	032 P1 S	037 P1 S	041 P1 S	045 P1 S
SIZE		E3	E3	E4L	E4L	E4L	E4L
<b>VAPOUR PRODUCTION</b>	kg/h	3,0	3,0	8,0	8,0	8,0	8,0
Power input	kW	2,3	2,3	6,0	6,0	6,0	6,0
Absorbed current (OA)	A	3,2	3,2	8,7	8,7	8,7	8,7
Max absorbed current (FLA)	A	4,5	4,5	12,4	12,4	12,4	12,4
Water content	l	3,9	3,9	6,4	6,4	6,4	6,4
Max water supply pressure	Bar	1÷8	1÷8	1÷8	1÷8	1÷8	1÷8
<b>NET WEIGHT (2)</b>	kg	6	6	10	10	10	10
<b>HYDRAULIC CONNECTION</b>							
WATER INLET - ISO 228/1 – G F	Ø	3/4"	3/4"	-	-	-	-
WATER INLET - ISO 228/1 – G M	Ø	-	-	3/4"	3/4"	3/4"	3/4"
WATER OUTLET - internal diameter	Ø mm	19	19	-	-	-	-
WATER OUTLET - external diameter	Ø mm	-	-	19	19	19	19

VERSION (1)		U / O	U / O	U / O	U / O	U / O	U / O
MODEL		039 P2 D	048 P2 D	055 P2 D	062 P2 D	075 P2 D	082 P2 D
SIZE		E5L	E5L	E6L	E6L	E7L	E7L
<b>VAPOUR PRODUCTION</b>	kg/h	8,0	8,0	8,0	8,0	8,0	8,0
Power input	kW	6,0	6,0	6,0	6,0	6,0	6,0
Absorbed current (OA)	A	8,7	8,7	8,7	8,7	8,7	8,7
Max absorbed current (FLA)	A	12,4	12,4	12,4	12,4	12,4	12,4
Water content	l	6,4	6,4	6,4	6,4	6,4	6,4
Max water supply pressure	Bar	1÷8	1÷8	1÷8	1÷8	1÷8	1÷8
<b>NET WEIGHT (2)</b>	kg	12	12	14	14	14	14
<b>HYDRAULIC CONNECTION</b>							
WATER INLET - ISO 228/1 – G F	Ø	-	-	-	-	-	-
WATER INLET - ISO 228/1 – G M	Ø	3/4"	3/4"	3/4"	3/4"	3/4"	3/4"
WATER OUTLET - internal diameter	Ø mm	-	-	-	-	-	-
WATER OUTLET - external diameter	Ø mm	19	19	19	19	19	19

VERSION (1)		U / O	U / O	U	U
MODEL		092 P2 D	102 P2 D	117 P4 D	146 P4 D
SIZE		E8L	E8L	E9L	E9L
<b>VAPOUR PRODUCTION</b>	kg/h	8,0	8,0	8,0	8,0
Power input	kW	6,0	6,0	6,0	6,0
Absorbed current (OA)	A	8,7	8,7	8,7	8,7
Max absorbed current (FLA)	A	12,4	12,4	12,4	12,4
Water content	l	6,4	6,4	6,4	6,4
Max water supply pressure	Bar	1÷8	1÷8	1÷8	1÷8
<b>NET WEIGHT (2)</b>	kg	14	14	14	14
<b>HYDRAULIC CONNECTION</b>					
WATER INLET - ISO 228/1 – G F	Ø	-	-	-	-
WATER INLET - ISO 228/1 – G M	Ø	3/4"	3/4"	3/4"	3/4"
WATER OUTLET - internal diameter	Ø mm	-	-	-	-
WATER OUTLET - external diameter	Ø mm	19	19	19	19

1. U = Under, downflow / O = Over, upflow
2. Value to be added to the weight of the standard unit. Does not include the weight of the water content.

## EXTRA POWER HUMIDIFIERS

The optional is not available for size E1.

The components are the same of the standard accessory

### TECHNICAL DATA

VERSION (1)		U / O	U / O	U / O	U / O	U / O	U / O
MODEL		007 P1 S	009 P1 S	011 P1 S	014 P1 S	016 P1 S	020 P1 S
SIZE		E1	E1	E1	E2	E2	E3
<b>VAPOUR PRODUCTION</b>	kg/h	--	--	--	<b>8,0</b>	<b>8,0</b>	<b>8,0</b>
Power input	kW	--	--	--	6,0	6,0	6,0
Absorbed current (OA)	A	--	--	--	8,7	8,7	8,7
Max absorbed current (FLA)	A	--	--	--	12,4	12,4	12,4
Water content	l	--	--	--	6,4	6,4	6,4
Max water supply pressure	Bar	--	--	--	1÷8	1÷8	1÷8
<b>NET WEIGHT (2)</b>	kg	--	--	--	10	10	10
<b>HYDRAULIC CONNECTION</b>							
WATER INLET - ISO 228/1 – G F	Ø	--	--	--	3/4"	3/4"	3/4"
WATER INLET - ISO 228/1 – G M	Ø	--	--	--	--	--	--
WATER OUTLET - internal diameter	Ø mm	--	--	--	19	19	19
WATER OUTLET - external diameter	Ø mm	--	--	--	--	--	--

VERSION (1)		U / O	U / O	U / O	U / O	U / O	U / O
MODEL		022 P1 S	026 P1 S	032 P1 S	037 P1 S	041 P1 S	045 P1 S
SIZE		E3	E3	E4L	E4L	E4L	E4L
<b>VAPOUR PRODUCTION</b>	kg/h	<b>8,0</b>	<b>8,0</b>	<b>15,0</b>	<b>15,0</b>	<b>15,0</b>	<b>15,0</b>
Power input	kW	6,0	6,0	11,3	11,3	11,3	11,3
Absorbed current (OA)	A	8,7	8,7	16,2	16,2	16,2	16,2
Max absorbed current (FLA)	A	12,4	12,4	23	23	23	23
Water content	l	6,4	6,4	10,3	10,3	10,3	10,3
Max water supply pressure	Bar	1÷8	1÷8	1÷8	1÷8	1÷8	1÷8
<b>NET WEIGHT (2)</b>	kg	10	10	16	16	16	16
<b>HYDRAULIC CONNECTION</b>							
WATER INLET - ISO 228/1 – G F	Ø	3/4"	3/4"	--	--	--	--
WATER INLET - ISO 228/1 – G M	Ø	--	--	3/4"	3/4"	3/4"	3/4"
WATER OUTLET - internal diameter	Ø mm	19	19	--	--	--	--
WATER OUTLET - external diameter	Ø mm	--	--	19	19	19	19

VERSION (1)		U / O	U / O	U / O	U / O	U / O	U / O
MODEL		039 P2 D	048 P2 D	055 P2 D	062 P2 D	075 P2 D	082 P2 D
SIZE		E5L	E5L	E6L	E6L	E7L	E7L
<b>VAPOUR PRODUCTION</b>	kg/h	<b>15,0</b>	<b>15,0</b>	<b>15,0</b>	<b>15,0</b>	<b>15,0</b>	<b>15,0</b>
Power input	kW	11,3	11,3	11,3	11,3	11,3	11,3
Absorbed current (OA)	A	16,2	16,2	16,2	16,2	16,2	16,2
Max absorbed current (FLA)	A	23	23	23	23	23	23
Water content	l	10,3	10,3	10,3	10,3	10,3	10,3
Max water supply pressure	Bar	1÷8	1÷8	1÷8	1÷8	1÷8	1÷8
<b>NET WEIGHT (2)</b>	kg	16	16	16	16	16	16
<b>HYDRAULIC CONNECTION</b>							
WATER INLET - ISO 228/1 – G F	Ø	--	--	--	--	--	--
WATER INLET - ISO 228/1 – G M	Ø	3/4"	3/4"	3/4"	3/4"	3/4"	3/4"
WATER OUTLET - internal diameter	Ø mm	--	--	--	--	--	--
WATER OUTLET - external diameter	Ø mm	19	19	19	19	19	19

1. U = Under, downflow / O = Over, upflow

2. Value to be added to the weight of the standard unit. Does not include the weight of the water content.

## TECHNICAL DATA

MODEL		U / O	U / O	U	U
SIZE		092 P2 D	102 P2 D	117 P4 D	146 P4 D
VERSION (1)		E8L	E8L	E9L	E9L
VAPOUR PRODUCTION	kg/h	15,0	15,0	15,0	15,0
Power input	kW	11,3	11,3	11,3	11,3
Absorbed current (OA)	A	16,2	16,2	16,2	16,2
Max absorbed current (FLA)	A	23	23	23	23
Water content	l	10,3	10,3	10,3	10,3
Max water supply pressure	Bar	1÷8	1÷8	1÷8	1÷8
NET WEIGHT (2)	kg	16	16	16	16
<b>HYDRAULIC CONNECTION</b>					
WATER INLET - ISO 228/1 – G F	Ø	--	--	--	--
WATER INLET - ISO 228/1 – G M	Ø	3/4"	3/4"	3/4"	3/4"
WATER OUTLET - internal diameter	Ø mm	--	--	--	--
WATER OUTLET - external diameter	Ø mm	19	19	19	19

1. U = Under, downflow / O = Over, upflow
2. Value to be added to the weight of the standard unit. Does not include the weight of the water content.

## OPTIONAL ACCESSORIES : P051 – DEHUMIDIFICATION FUNCTION

The optional requires mandatory accessory "P161 T/rH air intake sensor".

Components:

- T / rH air intake sensor.
- Electronic control system of the dew point temperature for the combined intervention of cooling capacity and air flow.

## OPTIONAL ACCESSORIES: P161 - T/RH AIR INTAKE SENSOR OPTIONAL ACCESSORIES: P071 - REMOTE T/RH PROBE



### P161: T/RH AIR INTAKE SENSOR

The accessory replaces the temperature sensor installed on the air intake in the unit and allows the displaying of the relative humidity room value

The sensor is mandatorily required with following option:

- 4301 / 4303 / 4305 Humidifier
- P161 Dehumidification function
- P034 Intake free-cooling plenum.

### P071: REMOTE T/RH PROBE

The accessory is added to the standard temperature sensor or to the temperature / humidity sensor (optional) on the machine air intake. For indoor installation in a specific point of the room to be conditioned.

## OPTIONAL ACCESSORIES: 4666 – EXTERNAL AIR PROBE



The probe must be installed protected against atmospheric agent and allows the displaying of the external air temperature.

The sensor is mandatorily required with following option:

- P034 Intake free-cooling plenum.

**OPTIONAL ACCESSORIES: P111 – DUAL POWER SUPPLY**

**OPTIONAL ACCESSORIES: P112 – DUAL POWER SUPPLY + OPTIONAL**

**OPTIONAL ACCESSORIES: P113 – KIT DUAL POWER SUPPLY**

**OPTIONAL ACCESSORIES: P114 – KIT DUAL POWER SUPPLY + OPTIONAL**



The motorised changeover switches automatically manage changeover under load between two three-phase power supplies, or manually for emergency operations. These devices are suitable for low voltage systems with interruption of the supply to the load during transfer. The model supplied in the automatic version checks the source and switches over automatically, based on configurable parameters.

**OPEN TRANSITION TYPE TRANSFER SWITCH WITH A MINIMUM INTERRUPTION OF THE SUPPLY DURING TRANSFER.**

To maintain the microprocessor powered and avoid its restarts it is suggested the “P091 Back-up module controller” optional accessory. The back-up module guarantees the microprocessor power supply for a few minutes, in case of supply voltage failure.

**INSTALLATION**

Frame	Power Supply	Installation	Code
E1	400/3+N/50	EXTERNAL to the unit, supplied in kit	P113, P114 (*)
E2	400/3+N/50	EXTERNAL to the unit, supplied in kit	P113, P114 (*)
E3	400/3+N/50	EXTERNAL to the unit, supplied in kit	P113, P114 (*)
E4L	400/3+N/50	EXTERNAL to the unit, supplied in kit	P113, P114 (*)
E5L	400/3+N/50	INTERNAL (on unit electrical panel)	P111, P112 (*)
E6L	400/3+N/50	INTERNAL (on unit electrical panel)	P111, P112 (*)
E7L	400/3+N/50	INTERNAL (on unit electrical panel)	P111, P112 (*)
E8L	400/3+N/50	INTERNAL (on unit electrical panel)	P111, P112 (*)
E9L	400/3+N/50	INTERNAL (on unit electrical panel)	P111, P112 (*)

(\*) P112, P114 for units with optional (with electric heaters and/or humidifier)

**MOUNTING KIT**

For EXTERNAL installation, the optional accessory is supplied in special box with IP 3X ingress protection, with the dimensions shown in the figure below.

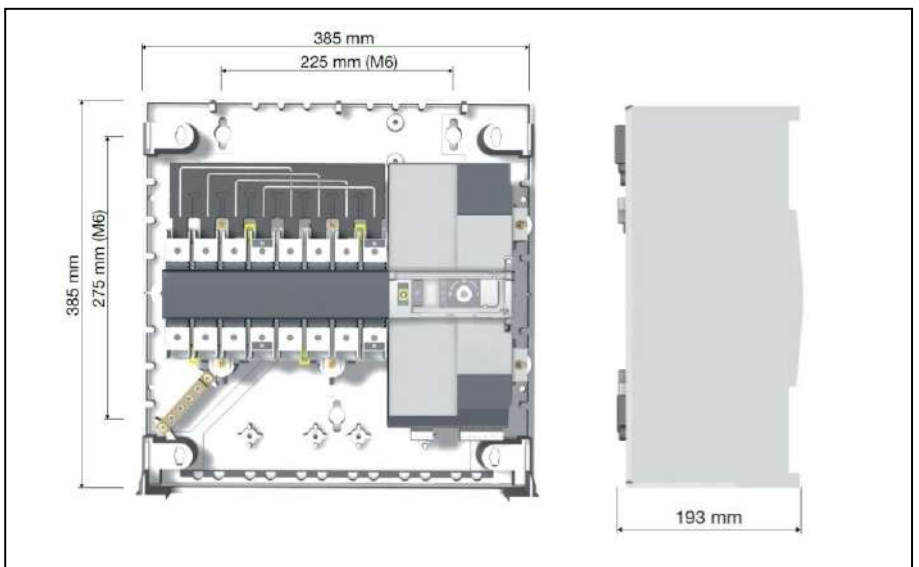

**OPTIONAL ACCESSORIES: A381 - DRAIN PUMP**



A plastic case contains the vertical type pump, the water tank with float plus safety switch and hydraulic and electric connection.

Together the pump 10 linear meters anti-crushing plastic discharge spiral tube is supplied. The optional must be installed as shown in the documentation delivered together with the unit.

Wiring includes power supply and an alarm, displayed on microprocessor, that includes motor pump thermal protection and tank overflow.

The condensate discharge pump operation is fully automatic.

**WARNING**

For all the machines the optional accessory is supplied in mounting kit.

**TECHNICAL DATA**

- Power supply: 230V~ 50Hz
- Electrical data: 70W – 0,67A
- Maximum water flow: 500 l/h
- Maximum delivery height: 5.0 m
- Sound level: 45dBA a 1 m
- Maximum water temperature: 70°C
- Water acidity: pH>2.5
- Tray volume: 2.0 l
- Protection IP 20

**CONDENSATE DISCHARGE PUMP**

(Dimensions in millimetres)

**OPERATING DATA**

Discharge head	Total length of discharge pipes (Ø 10 mm internal)			
	5m	10m	20m	30m
1m	380	300	240	190
2m	310	260	200	150
3m	240	200	145	110
4m	150	130	80	60
5m	30	20	0	0

## OPTIONAL ACCESSORIES: P084 – AIR FILTER ePM<sub>10</sub> 50%

The ePM<sub>10</sub> 50% air filters (according to ISO EN 16890), replace the standard one.  
The filters generate a pressure drops higher than the standard ones.  
The filters are made of glass micro-fibre and are not regenerable.

VERSION (1)		U / O	U / O	U / O	U / O	U / O	U / O
MODEL		007 P1 S	009 P1 S	011 P1 S	014 P1 S	016 P1 S	020 P1 S
SIZE		E1	E1	E1	E2	E2	E3
Additional pressure drops (2)	Pa	42	47	53	65	70	54

VERSION (1)		U / O	U / O	U / O	U / O	U / O	U / O
MODEL		022 P1 S	026 P1 S	032 P1 S	037 P1 S	041 P1 S	045 P1 S
SIZE		E3	E3	E4L	E4L	E4L	E4L
Additional pressure drops (2)	Pa	62	68	30	39	45	45

VERSION (1)		U / O	U / O	U / O	U / O	U / O	U / O
MODEL		039 P2 D	048 P2 D	055 P2 D	062 P2 D	075 P2 D	082 P2 D
SIZE		E5L	E5L	E6L	E6L	E7L	E7L
Additional pressure drops (2)	Pa	23	35	41	44	72	72

VERSION (1)		U / O	U / O	U	U
MODEL		092 P2 D	102 P2 D	117 P4 D	146 P4 D
SIZE		E8L	E8L	E9L	E9L
Additional pressure drops (2)	Pa	69	69	94	94

1. U = Under, downflow / O = Over, upflow
2. Additional pressure drops referred to nominal air flow and clean filter.

**OPTIONAL ACCESSORIES: A531 – ON-OFF DAMPER**

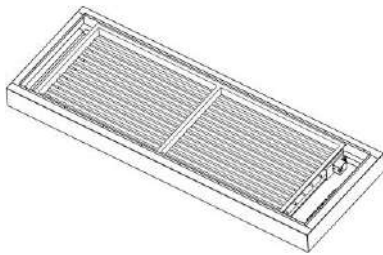

Non-return air damper with frame driven by electric servomotor.  
 Accessory installed on units air delivery and it can be matched to plenums and floor stand.  
 The accessory requires mandatory accessory "9973 Wooden cage packing".

**FRAMEWORK**

- Frame in galvanized steel sheet with protective surfaces treatment in compliance with UNI ISO 9227/ASTMB117 and ISO 7253, and painted with epoxy powders. Colour RAL 9005;
- Opposed blade dampers in galvanized steel sheet.
- Actuator for damper control.
- Terminals for electric connection to the unit.

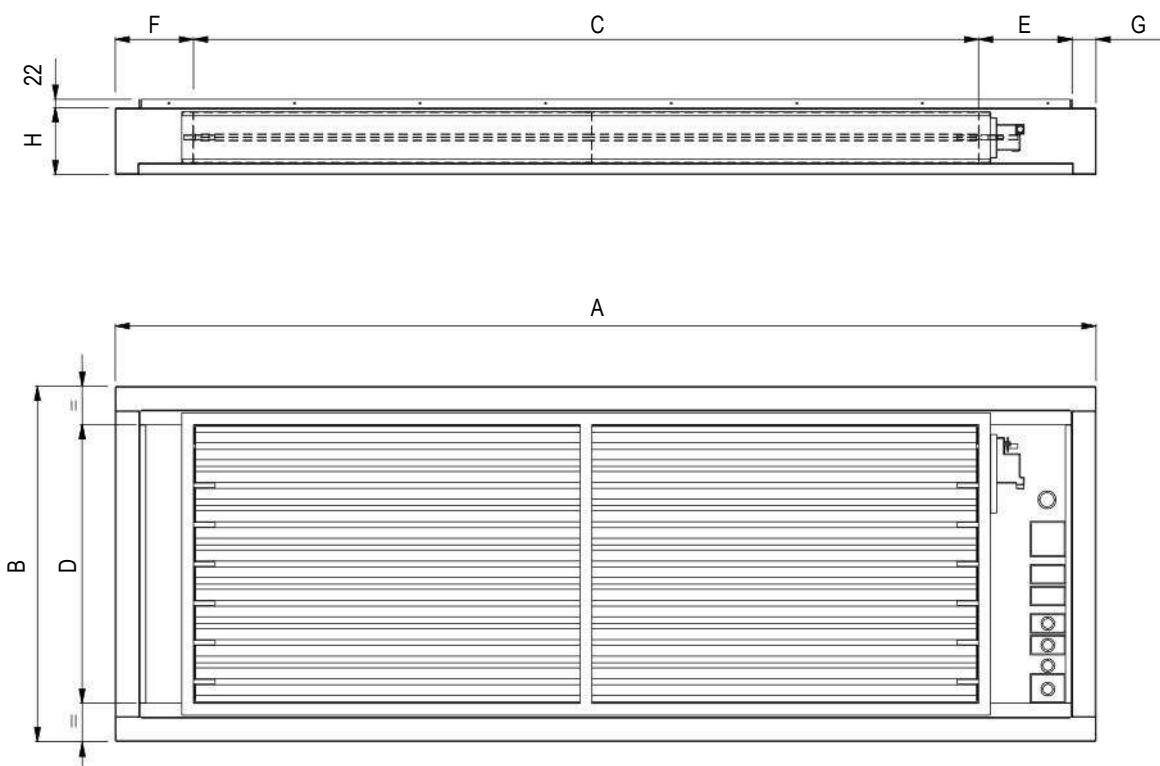

VERSION (1)		U / O	U / O	U / O	U / O	U / O	U / O	U / O	U	
SIZE		E1	E2	E3	E4L	E5L	E6L	E7L	E8L	E9L
A	mm	650	785	1085	1630	1955	2198	2499	2899	3299
B	mm	650	650	750	905	905	905	905	905	905
C	mm	300	450	750	900	1250	1500	1750	2000	2300
D	mm	510	510	610	710	710	710	710	710	710
E	mm	231	216	216	467	529	575,5	550,5	638,5	638,5
F	mm	73	73	73	202	115	61,5	137,5	199,5	299,5
G	mm	46	46	46	61	61	61	61	61	61
H	mm	170	170	170	170	170	170	170	170	170
Weight (2)	kg	20	23	30	45	55	63	70	80	95

1. U = Under, downflow / O = Over, upflow  
 2. Add this value to the total unit weight



INSTALLATION EXAMPLE

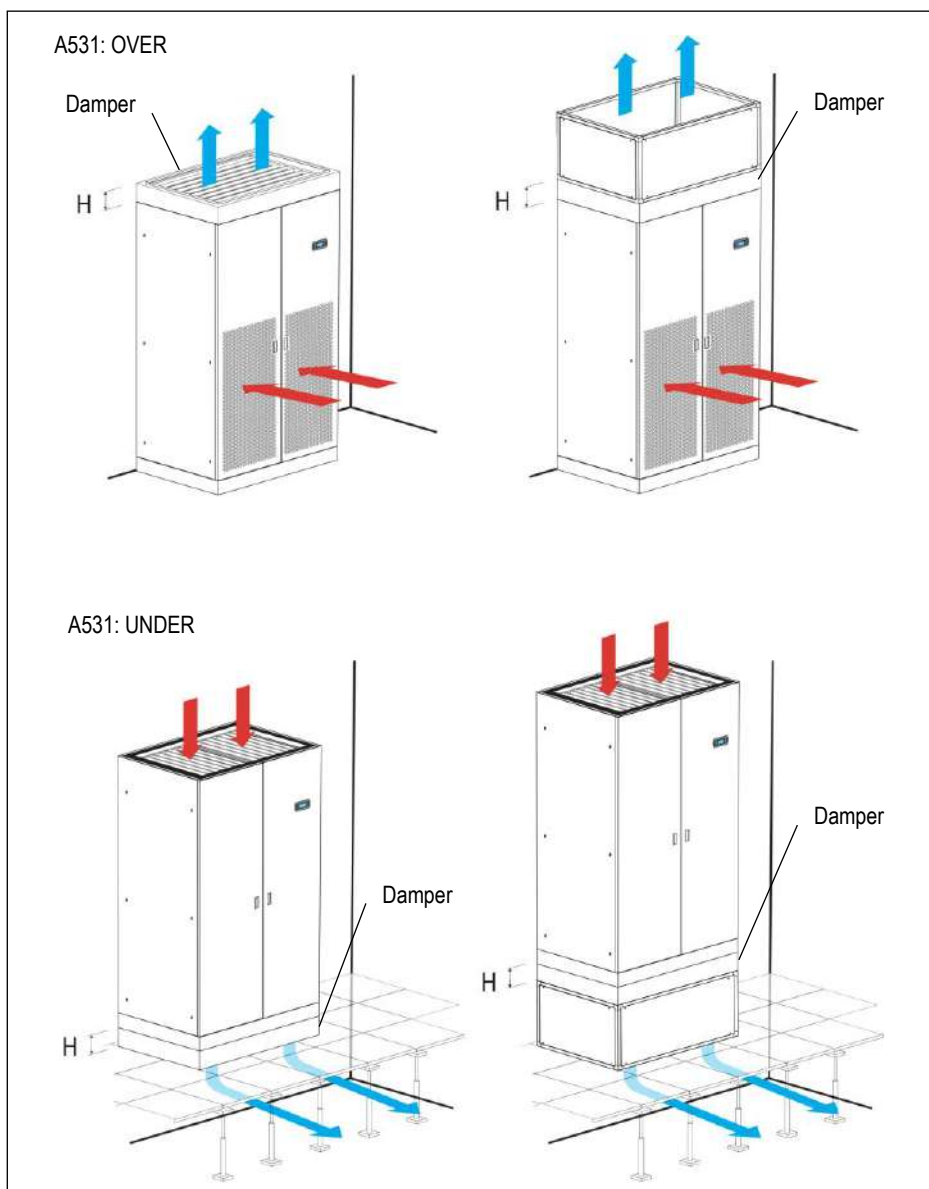

WORKING LOGIC

The damper opens at supply fans activation to allow air flow.

When the fans stop for failure or stop command, the damper closes, preventing air flow into the unit.

OPTIONAL ACCESSORIES: P011 - EMPTY PLENUM

OPTIONAL ACCESSORIES: P012 - EMPTY PLENUM CL.A1

OPTIONAL ACCESSORIES: P031 - EMPTY INTAKE PLENUM

OPTIONAL ACCESSORIES: P032 - EMPTY INTAKE PLENUM CL.A1

OPTIONAL ACCESSORIES: P013 - PLENUM + 3 GRILLES

OPTIONAL ACCESSORIES: P014 - PLENUM + 3 GRILLES CL.A1

OPTIONAL ACCESSORIES: P015 - SILENCED PLENUM

OPTIONAL ACCESSORIES: P016 - SILENCED PLENUM + 1 GRILLE

OPTIONAL ACCESSORIES: P017 - PLENUM + FILTER EPM2.5 50%

OPTIONAL ACCESSORIES: P018 - PLENUM + FILTER EPM1 50%

OPTIONAL ACCESSORIES: P019 - PLENUM + FILTER EPM1 85%

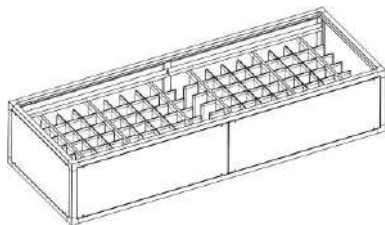
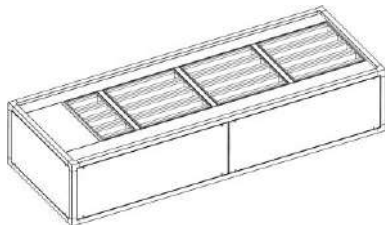
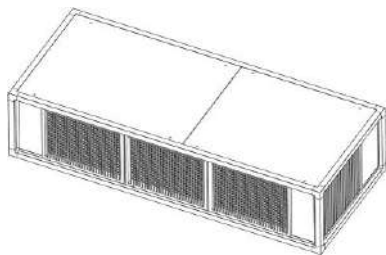
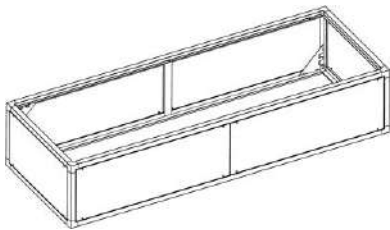

The optional is supplied separately and the installation on the unit is at Customer care.  
The plenums have same technical characteristics and base dimensions of the machine cabinet.

**It is possible to install only a single plenum to ensure stability to the unit.**

#### FRAMEWORK

- Frame in aluminium extrusion, painted with epoxy powders. Colour RAL 9005;
- Panels in galvanized steel sheet with protective surfaces treatment in compliance with UNI ISO 9227/ASTMB117 and ISO 7253, and painted with epoxy powders. Colour RAL 9005;
- Panels insulated with polyurethane foam and seals to ensure air tight.
- Panels fixed with screws.
- Removable panels.
- Set of fixing elements to fasten the plenum to the unit.

#### WARNING

In UNDER version units the piping is inside the machine.

The air delivery plenums sometime don't allow the extension of the pipes downwards.

In special cases, to keep the connections inside the machine, foresee a plenum 200mm higher than the standard one.

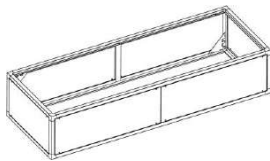

**P011 / P012 – P031 / P032: EMPTY PLENUM**

The plenum is void and can be used to rise the intake/delivery air inlet/outlet. Remove the frontal panels for inspection.

Also available with fire reaction in class “0” or “A1” (EN 13501-1).

The optional accessories “P031 Empty intake plenum, for OVER version” and “P032 Empty intake plenum CL.A1, for OVER version” require mandatory accessory “P122 Bottom air intake+blind panels, for OVER version only”.

P011 / P012 OVER

P031 / P032 OVER

P122 Bottom air intake+blind panels

P011 / P012 UNDER

P031 / P032 UNDER

VERSION (1)		U / O	U / O	U / O	U / O	U / O	U / O	U / O	U / O	U
SIZE		E1	E2	E3	E4L	E5L	E6L	E7L	E8L	E9L
A	mm	490	490	490	510	510	510	510	510	510
Weight (2)	kg	20	21	20	40	45	50	60	70	80
Weight CL.0 or A1 (EN 13501-1) (2)	kg	25	27	27	50	56	62	74	85	97

1. U = Under, downflow / O = Over, upflow
2. Add this value to the total unit weight

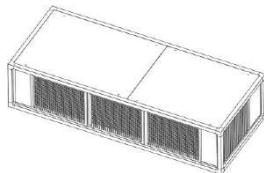

**P013 / P014: PLENUM + 3 GRILLES**

The plenum must be installed on air delivery.

The plenum allows the air distribution directly into the room. The plenum is supplied with air distribution grilles with double row adjustable grilles on front and lateral side.

Also available with fire reaction in class “0” or “A1” (EN 13501-1).

P013 / P014 OVER

P013 / P014 UNDER

VERSION (1)		U / O	U / O	U / O	U / O	U / O	U / O	U / O	U / O	U
SIZE		E1	E2	E3	E4L	E5L	E6L	E7L	E8L	E9L
A	mm	490	490	490	510	510	510	510	510	510
Weight (2)	kg	21	23	30	50	55	70	90	100	120
Weight CL.0 or A1 (EN 13501-1) (2)	kg	25	28	37	61	68	84	106	118	140

1. U = Under, downflow / O = Over, upflow
2. Add this value to the total unit weight

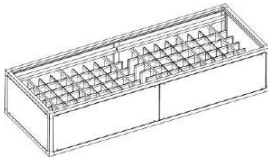

## P015: SILENCED PLENUM

The plenum must be installed on air delivery.

The plenum is fitted with noise absorption partitions to reduce the noise emission.  
Remove the frontal panels for inspection.

P015 OVER

P015 UNDER

VERSION (1)		U / O	U / O	U / O	U / O	U / O	U / O	U / O	U / O	U
SIZE		E1	E2	E3	E4L	E5L	E6L	E7L	E8L	E9L
A	mm	490	490	490	510	510	510	510	510	510
Weight (2)	kg	25	27	30	50	55	70	90	100	110

1. U = Under, downflow / O = Over, upflow
2. Add this value to the total unit weight

## ACOUSTIC DATA

VERSION (1)		U / O	U / O	U / O	U / O	U / O	U / O
MODEL		007 P1 S	009 P1 S	011 P1 S	014 P1 S	016 P1 S	020 P1 S
SIZE		E1	E1	E1	E2	E2	E3
<b>SOUND LEVEL ISO 3744 (2)</b>							
On air delivery, Under	dB(A)	59,3	61,0	61,7	66,7	67,8	66,4
On air intake, Under	dB(A)	53,8	55,2	56,1	57,4	58,5	57,3
On front side, Under	dB(A)	44,5	46,0	46,9	48	49,1	47,9
On air delivery, Over	dB(A)	58,0	59,6	60,4	66,7	67,8	66,4
On air intake, Over (3)	dB(A)	49,6	50,0	51,7	54,1	55,5	55,4
On front side, Over (4)	dB(A)	39,7	41,0	42,0	47,6	48,6	47,0
Air flow (5)	m <sup>3</sup> /h	2500	2700	2800	4000	4200	5700

VERSION (1)		U / O	U / O	U / O	U / O	U / O	U / O
MODEL		022 P1 S	026 P1 S	032 P1 S	037 P1 S	041 P1 S	045 P1 S
SIZE		E3	E3	E4L	E4L	E4L	E4L
<b>SOUND LEVEL ISO 3744 (2)</b>							
On air delivery, Under	dB(A)	67,9	68,9	73,8	76,8	74,6	74,6
On air intake, Under	dB(A)	59,2	59,5	64,1	67,0	66,4	66,4
On front side, Under	dB(A)	49,9	50,1	54,6	57,5	57,0	57,0
On air delivery, Over	dB(A)	67,9	68,9	73,8	76,8	74,6	74,6
On air intake, Over (3)	dB(A)	58,6	57,0	60,5	62,6	62,4	62,4
On front side, Over (4)	dB(A)	48,9	49,4	54,3	57,3	56,7	56,7
Air flow (5)	m <sup>3</sup> /h	6100	6400	8700	10000	10800	10800

1. U = Under, downflow / O = Over, upflow
2. Noise pressure level at 1 meter in free field – ISO 3744
3. Air intake from the front
4. Air intake from the bottom
5. Nominal air flow with noise absorption partitions plenum installation and external static pressure 20 Pa.

## ACOUSTIC DATA

VERSION (1)		U / O	U / O	U / O	U / O	U / O	U / O
MODEL		039 P2 D	048 P2 D	055 P2 D	062 P2 D	075 P2 D	082 P2 D
SIZE		E5L	E5L	E6L	E6L	E7L	E7L
<b>SOUND LEVEL ISO 3744 (2)</b>							
On air delivery, Under	dB(A)	77,0	77,1	73,7	74,6	75,9	75,9
On air intake, Under	dB(A)	67,2	68,9	64,2	65,1	67,7	67,7
On front side, Under	dB(A)	57,7	59,4	54,7	55,7	58,4	58,4
On air delivery, Over	dB(A)	77,0	77,1	73,7	74,6	75,9	75,9
On air intake, Over (3)	dB(A)	62,7	64,3	60,9	62,3	63,9	63,9
On front side, Over (4)	dB(A)	57,5	59,3	54,2	55,1	58,0	58,0
Air flow (5)	m <sup>3</sup> /h	10000	12000	15000	15600	20000	20000

VERSION (1)		U / O	U / O	U	U
MODEL		092 P2 D	102 P2 D	117 P4 D	146 P4 D
SIZE		E8L	E8L	E9L	E9L
<b>SOUND LEVEL ISO 3744 (2)</b>					
On air delivery, Under	dB(A)	78,1	78,1	79,1	79,1
On air intake, Under	dB(A)	69,9	69,9	70,9	70,9
On front side, Under	dB(A)	60,6	60,6	61,4	61,4
On air delivery, Over	dB(A)	78,1	78,1	--	--
On air intake, Over (3)	dB(A)	66,1	66,1	--	--
On front side, Over (4)	dB(A)	60,3	60,3	--	--
Air flow (5)	m <sup>3</sup> /h	22000	22000	32000	32000

1. U = Under, downflow / O = Over, upflow
2. Noise pressure level at 1 meter in free field – ISO 3744
3. Air intake from the front
4. Air intake from the bottom
5. Nominal air flow with noise absorption partitions plenum installation and external static pressure 20 Pa

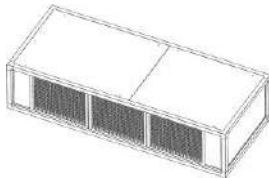

### P016: SILENCED PLENUM + 1 GRILLE

The plenum must be installed on air delivery.

The plenum allows the frontal air distribution directly into the room and a noise reduction of the air delivery. The plenum is supplied with air distribution grille with double row adjustable grilles on front side and noise absorption partitions,

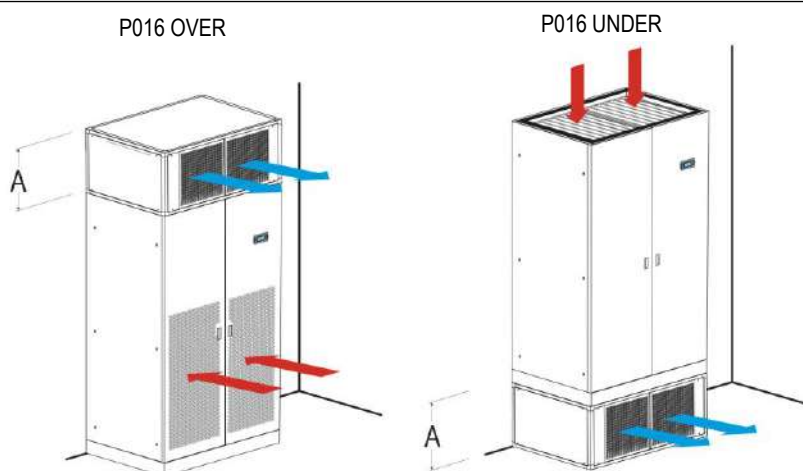

VERSION (1)		U / O	U / O	U / O	U / O	U / O	U / O	U / O	U	
SIZE		E1	E2	E3	E4L	E5L	E6L	E7L	E8L	E9L
A	mm	490	490	490	510	510	510	510	510	510
Weight (2)	kg	30	30	37	72	77	85	115	130	140

1. U = Under, downflow / O = Over, upflow
2. Add this value to the total unit weight

## ACOUSTIC DATA

VERSION (1)		U / O	U / O	U / O	U / O	U / O	U / O
MODEL		007 P1 S	009 P1 S	011 P1 S	014 P1 S	016 P1 S	020 P1 S
SIZE		E1	E1	E1	E2	E2	E3
<b>SOUND LEVEL ISO 3744 (2)</b>							
On air delivery, Under	dB(A)	58,3	59,9	60,0	67,3	68,3	66,3
On air intake, Under	dB(A)	53,5	54,9	55,8	58,1	59,2	57,7
On front side, Under	dB(A)	44	46	46,6	48,7	49,8	48,3
On air delivery, Over	dB(A)	58,3	59,9	60,0	67,3	68,3	66,3
On air intake, Over (3)	dB(A)	49,7	50,1	51,6	53,8	55,2	55,3
Irradiated Over (4)	dB(A)	40,1	41,4	41,8	47,1	48,1	46,7
ADDITIONAL PRESSURE DROPS (5)	Pa	45	51	77	79	87	63
AIR FLOW	m <sup>3</sup> /h	2500	2700	2700	4000	4200	5700

VERSION (1)		U / O	U / O	U / O	U / O	U / O	U / O
MODEL		022 P1 S	026 P1 S	032 P1 S	037 P1 S	041 P1 S	045 P1 S
SIZE		E3	E3	E4L	E4L	E4L	E4L
<b>SOUND LEVEL ISO 3744 (2)</b>							
On air delivery, Under	dB(A)	67,7	68,7	73,1	76,1	73,9	73,9
On air intake, Under	dB(A)	59,6	60,0	64,1	67,0	66,4	66,4
On front side, Under	dB(A)	50,3	50,5	54,6	57,4	57,0	57,0
On air delivery, Over	dB(A)	67,7	68,7	73,1	76,1	73,9	73,9
On air intake, Over (3)	dB(A)	58,5	56,9	60,5	62,6	62,4	62,1
Irradiated Over (4)	dB(A)	48,7	49,0	54,3	57,3	56,8	56,8
ADDITIONAL PRESSURE DROPS (5)	Pa	72	79	69	92	106	106
AIR FLOW	m <sup>3</sup> /h	6100	6400	8700	10000	10800	10800

VERSION (1)		U / O	U / O	U / O	U / O	U / O	U / O
MODEL		039 P2 D	048 P2 D	055 P2 D	062 P2 D	075 P2 D	082 P2 D
SIZE		E5L	E5L	E6L	E6L	E7L	E7L
<b>SOUND LEVEL ISO 3744 (2)</b>							
On air delivery, Under	dB(A)	76,2	76,4	73,3	74,1	75,3	75,3
On air intake, Under	dB(A)	67,1	68,7	64,4	65,3	67,8	67,9
On front side, Under	dB(A)	57,6	59,3	54,9	55,9	58,4	58,5
On air delivery, Over	dB(A)	76,2	76,4	73,3	74,1	75,3	75,3
On air intake, Over (3)	dB(A)	62,8	64,4	60,8	62,2	63,9	64,3
Irradiated Over (4)	dB(A)	57,6	59,4	54,1	55,0	58,1	58,1
ADDITIONAL PRESSURE DROPS (5)	Pa	57	85	100	108	133	133
AIR FLOW	m <sup>3</sup> /h	10000	12000	15000	15600	20000	20000

VERSION (1)		U / O	U / O	U	U
MODEL		092 P2 D	102 P2 D	117 P4 D	146 P4 D
SIZE		E8L	E8L	E9L	E9L
<b>SOUND LEVEL ISO 3744 (2)</b>					
On air delivery, Under	dB(A)	77,3	77,3	78,5	78,5
On air intake, Under	dB(A)	69,8	69,9	70,9	70,9
On front side, Under	dB(A)	60,4	60,5	61,5	61,5
On air delivery, Over	dB(A)	77,3	77,3	--	--
On air intake, Over (3)	dB(A)	66,2	66,5	--	--
Irradiated Over (4)	dB(A)	60,4	60,4	--	--
ADDITIONAL PRESSURE DROPS (5)	Pa	121	121	191	191
AIR FLOW	m <sup>3</sup> /h	22000	22000	32000	32000

1. U = Under, downflow / O = Over, upflow
2. Noise pressure level at 1 meter in free field – ISO 3744
3. Air intake from the front
4. Air intake from the bottom
5. Value to be subtracted from the nominal external static pressure of the unit

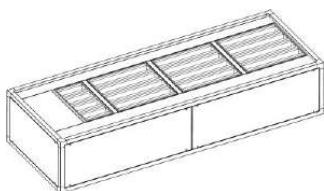

### P017 / P018 / P019: SUPPLY PLENUM + FILTER

The plenum must be installed on air delivery.  
 The optional is not compatible with "P084 Air filter ePM10 50%".  
 The plenum is fitted with high efficiency rigid bag filters.  
 Filters are made of glass micro fibre and are not regenerable.  
 Remove the frontal panels for filters replacement.

P017 / P018 / P019 OVER

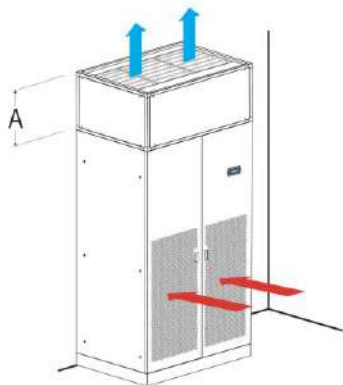

P017 / P018 / P019 UNDER

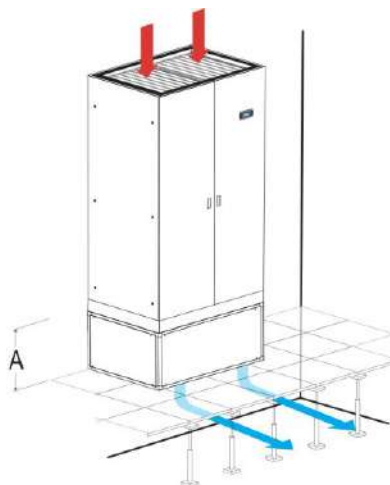

VERSION (1)		U / O	U / O	U / O	U / O	U / O	U / O	U / O	U	
SIZE		E1	E2	E3	E4L	E5L	E6L	E7L	E8L	E9L
A	mm	490	490	490	510	510	510	510	510	510
Weight (2)	kg	26	27	30	55	60	70	90	100	110

1. U = Under, downflow / O = Over, upflow
2. Add this value to the total unit weight

VERSION (1)		U / O	U / O	U / O	U / O	U / O	U / O
MODEL		007 P1 S	009 P1 S	011 P1 S	014 P1 S	016 P1 S	020 P1 S
SIZE		E1	E1	E1	E2	E2	E3
<b>PRESSURE DROPS (2)</b>							
Filters ePM <sub>2.5</sub> 50%	Pa	50	57	85	89	97	82
Filters ePM <sub>1</sub> 50%	Pa	62	71	98	129	138	120
Filters ePM <sub>1</sub> 85%	Pa	75	86	115	151	165	141

VERSION (1)		U / O	U / O	U / O	U / O	U / O	U / O
MODEL		022 P1 S	026 P1 S	032 P1 S	037 P1 S	041 P1 S	045 P1 S
SIZE		E3	E3	E4L	E4L	E4L	E4L
<b>PRESSURE DROPS (2)</b>							
Filters ePM <sub>2.5</sub> 50%	Pa	94	102	60	80	93	93
Filters ePM <sub>1</sub> 50%	Pa	134	145	94	118	133	133
Filters ePM <sub>1</sub> 85%	Pa	158	173	110	139	158	158

1. U = Under, downflow / O = Over, upflow
2. Data referred to the nominal air flow and clean filters. Value to be subtracted from the nominal external static pressure of the unit.

## t-AV DW

VERSION (1)		U / O	U / O	U / O	U / O	U / O	U / O
MODEL		039 P2 D	048 P2 D	055 P2 D	062 P2 D	075 P2 D	082 P2 D
SIZE		E5L	E5L	E6L	E6L	E7L	E7L
<b>PRESSURE DROPS (2)</b>							
Filters ePM <sub>2.5</sub> 50%	Pa	55	82	104	112	111	111
Filters ePM <sub>1</sub> 50%	Pa	88	121	147	158	157	157
Filters ePM <sub>1</sub> 85%	Pa	103	142	175	187	186	186

VERSION (1)		U / O	U / O	U	U
MODEL		092 P2 D	102 P2 D	117 P4 D	146 P4 D
SIZE		E8L	E8L	E9L	E9L
<b>PRESSURE DROPS (2)</b>					
Filters ePM <sub>2.5</sub> 50%	Pa	117	117	192	192
Filters ePM <sub>1</sub> 50%	Pa	139	139	230	231
Filters ePM <sub>1</sub> 85%	Pa	164	164	275	275

1. U = Under, downflow / O = Over, upflow
2. Data referred to the nominal air flow and clean filters. Value to be subtracted from the nominal external static pressure of the unit.



OPTIONAL ACCESSORIES: P034 – INTAKE FREE-COOLING PLENUM

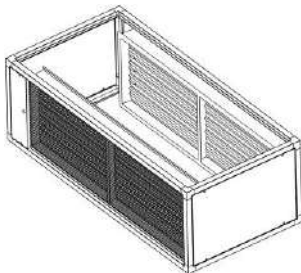
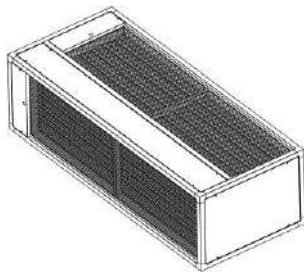

The optional is supplied separately and the installation on the unit is at Customer care.  
 The optional requires mandatory accessories "P161 T/rH air intake sensor", "4666 External air probe", "A812 Free-cooling direct control" and "P122 Bottom air intake+blind panels, for OVER version only".  
 The plenums have same technical characteristics and base dimensions of the machine cabinet.  
 The optional allow to obtain free-cooling by direct ambient air intake into the room.  
 The dampers are proportionally managed by the microprocessor control, that regulates the quantity of the ambient air to put in the room per the set-point.

COMPONENTS

- Frame in aluminium extrusion, painted with epoxy powders. Colour RAL 9005;
- Panels in galvanized steel sheet with protective surfaces treatment in compliance with UNI ISO 9227/ASTMB117 and ISO 7253, and painted with epoxy powders. Colour RAL 9005;
- Panels insulated with polyurethane foam and seals to ensure air tight.
- Removable panels with screws.
- Opposed blade dampers in galvanized steel sheet and safety grille for ambient air and room air suction.
- Actuator for each damper.
- Terminals for electric connection to the unit.
- Set of fixing elements to fasten the plenum to the unit.
- T / rH air intake sensor. The sensor must be moved outside the air conditioners for a proper read of the room temperature value.
- External air probe. The sensor must be installed in the outdoor air suction duct or anyway protected against atmospheric agent.
- Free contact for free-cooling operating status monitoring.
- Terminals on indoor unit for:
  - 24 Vac power supply for the overpressure damper servomotor
  - 0-10Vdc control signal for the servomotor

INSTALLATION EXAMPLE

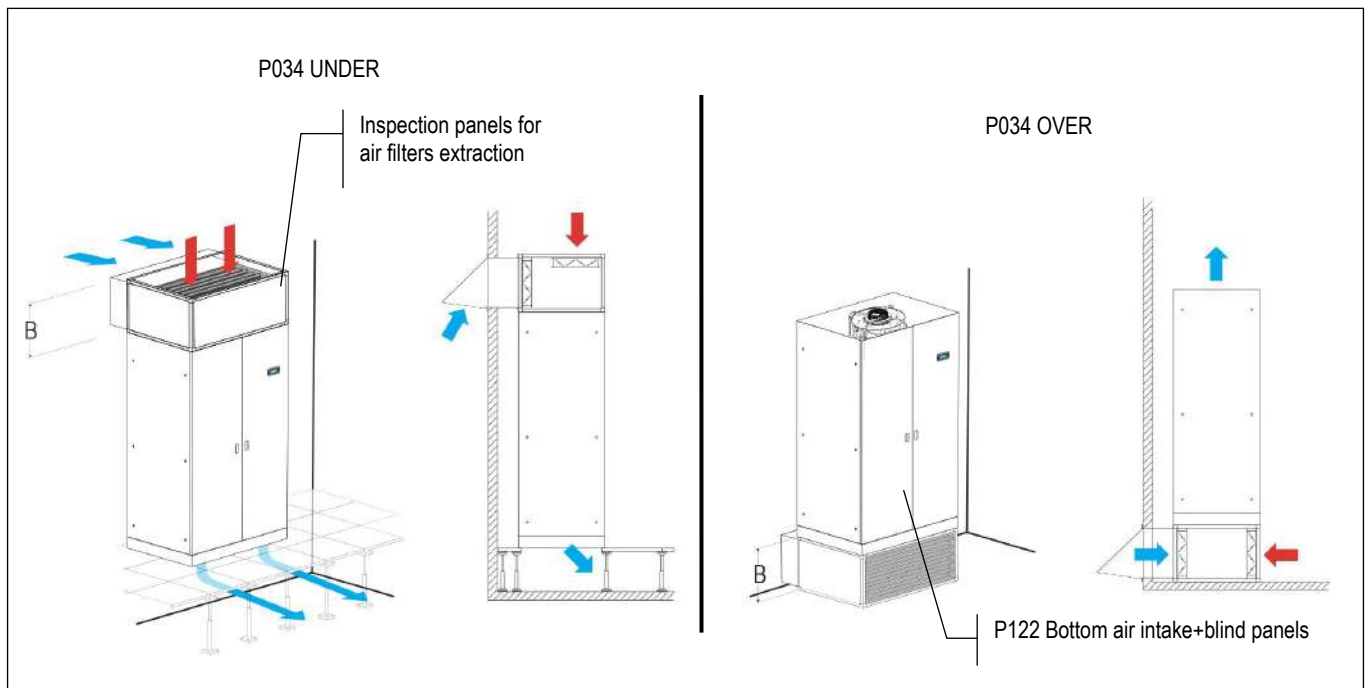

Ducting for ambient air suction are at Customer care.  
 A rain cover with grille on ambient air intake is recommended.

OVER VERSION

SIZE E1 / E2 / E3

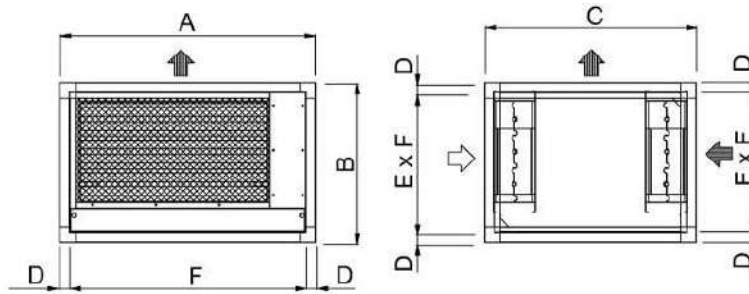

SIZE E4L / E5L

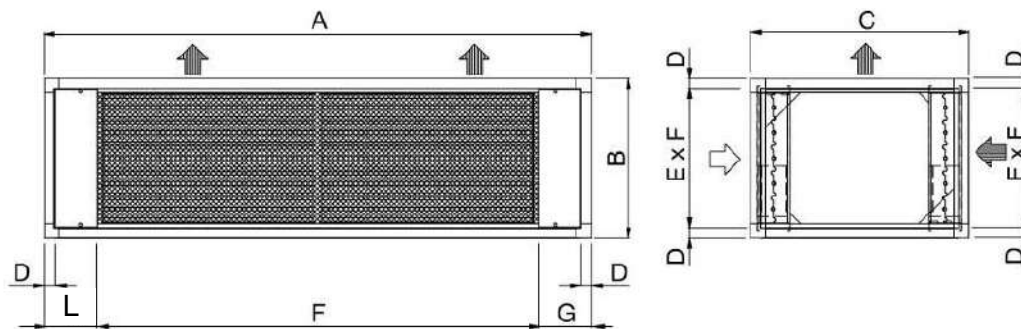

SIZE E6L / E7L / E8L

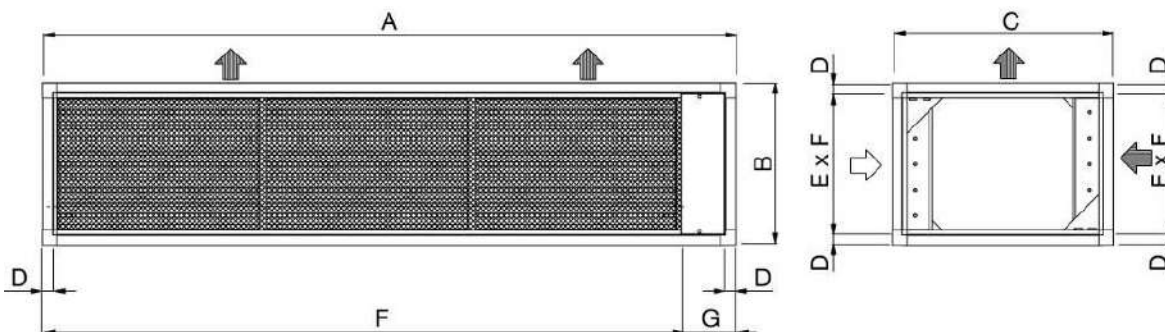

VERSION (1)		O	O	O	O	O	O	O	O	O
SIZE		E1	E2	E3	E4L	E5L	E6L	E7L	E8L	E9L
A	mm	650	785	1085	1630	1955	2198	2499	2899	--
B	mm	490	490	490	630	630	630	630	630	--
C	mm	650	650	750	905	905	905	905	905	--
D	mm	30	30	30	40	40	40	40	40	--
E	mm	430	430	430	550	550	550	550	550	--
F	mm	590	725	1025	1335	1335	1664	1965	2220	--
G	mm	--	--	--	147,5	472,5	534	534	679	--
L	mm	--	--	--	147,5	147,5	--	--	--	--
Weight (2)	kg	24	27	35	61	66	85	110	130	--

1. U = Under, downflow / O = Over, upflow
2. Add this value to the total unit weight

UNDER VERSION

SIZE E1 / E2 / E3

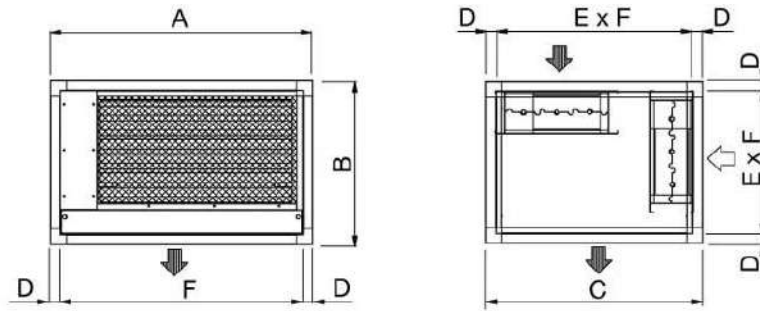

SIZE E4L / E5L

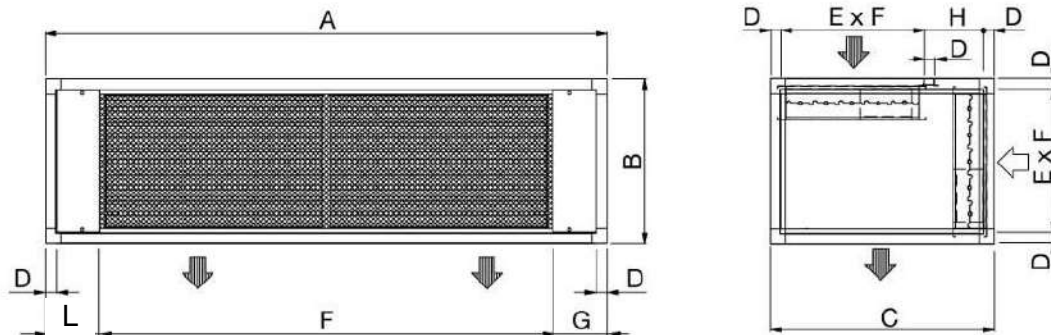

SIZE E6L / E7L / E8L / E9L

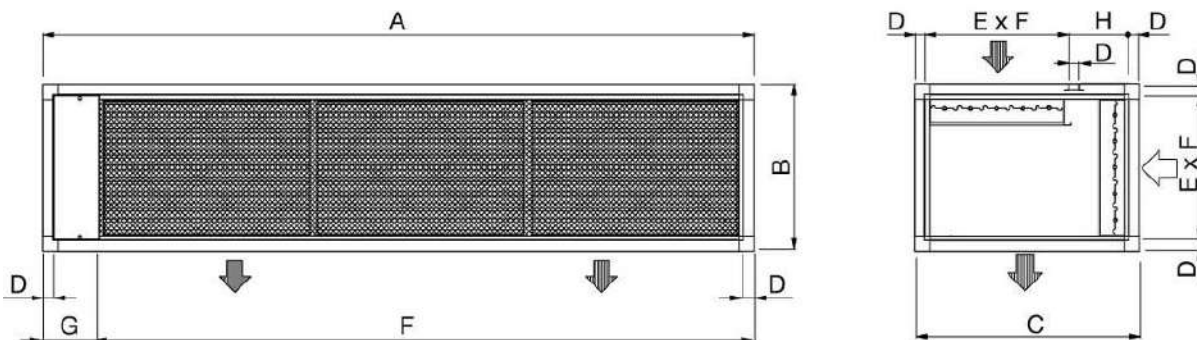

VERSION (1)		U	U	U	U	U	U	U	U	U
SIZE		E1	E2	E3	E4L	E5L	E6L	E7L	E8L	E9L
A	mm	650	785	1085	1630	1955	2198	2499	2899	3299
B	mm	490	490	490	630	630	630	630	630	630
C	mm	650	650	750	905	905	905	905	905	905
D	mm	30	30	30	40	40	40	40	40	40
E	mm	430	430	430	550	550	550	550	550	550
F	mm	590	725	1025	1335	1335	1664	1965	2220	2375
G	mm	--	--	--	147,5	472,5	534	534	679	924
H	mm	--	--	--	275	275	275	275	275	275
L	mm	--	--	--	147,5	147,5	--	--	--	--
Weight (2)	kg	24	27	35	61	66	85	110	130	150

1. U = Under, downflow / O = Over, upflow
2. Add this value to the total unit weight

**WARNING**

**IT IS COMPULSORY TO INSTALL INTO THE ROOM AN APPROPRIATELY SIZED OVERPRESSURE DAMPER TO ALLOW THE ROOM AIR EXHAUSTION DURING FREE-COOLING WORKING MODE**

**OVERPRESSURE DAMPER – Not supplied**

During free-cooling operation, the air conditioner supplies ambient air directly into the room, this causes an increase in air pressure inside the room.

The overpressure damper avoids the increase in pressure in the room.

The damper must be installed at the highest point of the room to expel excess hot air to the outside.

Install the damper if possible in opposite position to air conditioner.

Air exhaustion must be protected with a rain cover and a grille (at Customer care).

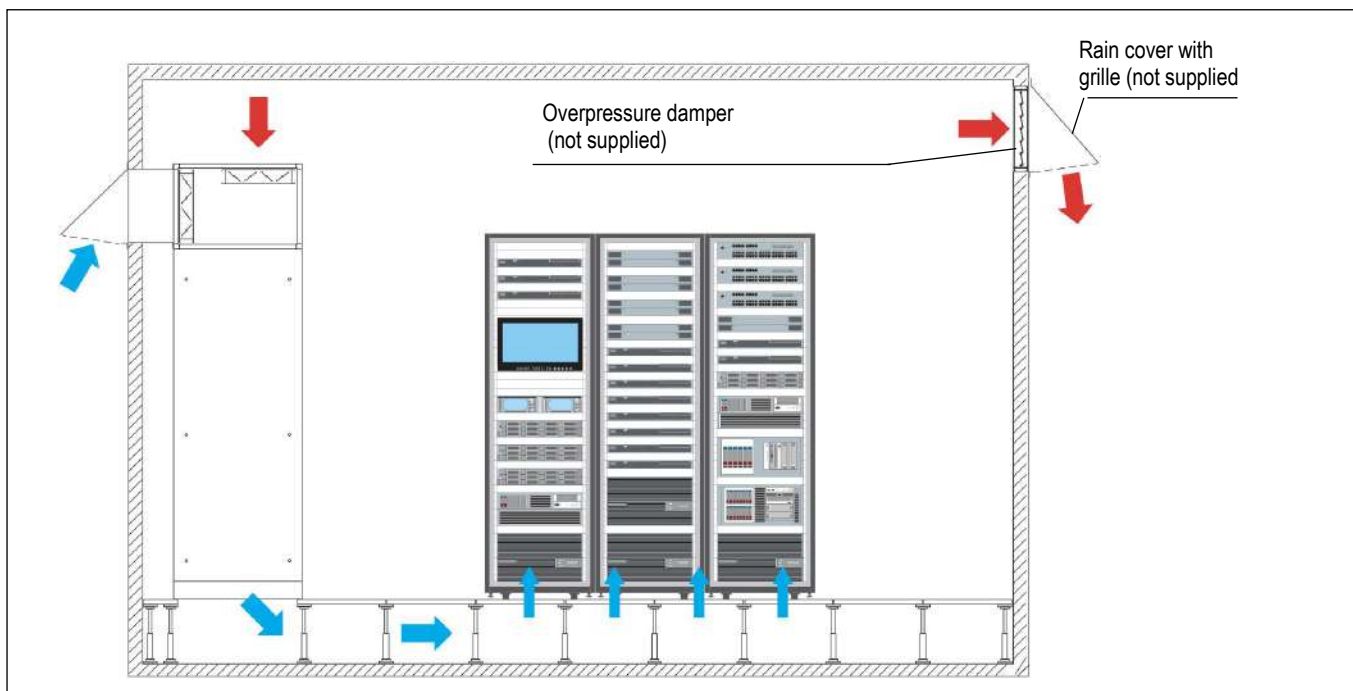

**OPTIONAL ACCESSORIES: P041 – SUPPORT FRAME H 255-350MM**

**OPTIONAL ACCESSORIES: P042 – SUPPORT FRAME H 355-450MM**

**OPTIONAL ACCESSORIES: P043 – SUPPORT FRAME H 400-510MM**

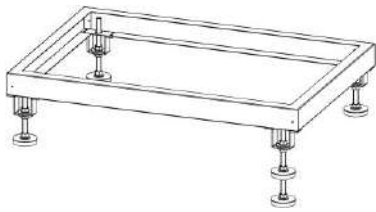

The accessory is supplied as an assembly kit.  
It is not possible to match the unit floor stand with plenum installed under the machine.  
The floor stand is available in 3 different heights.

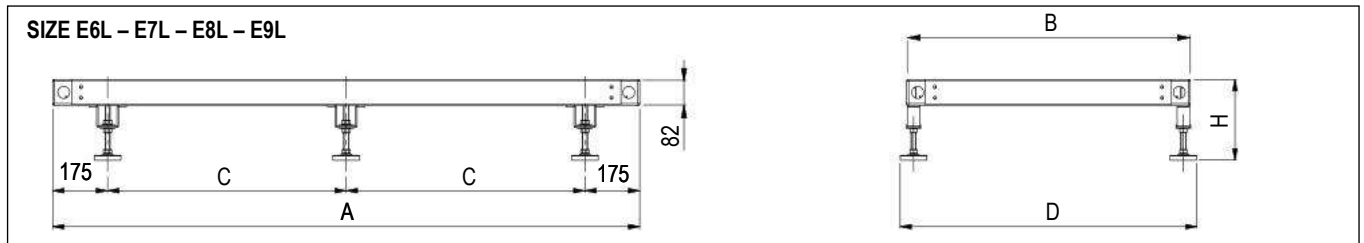
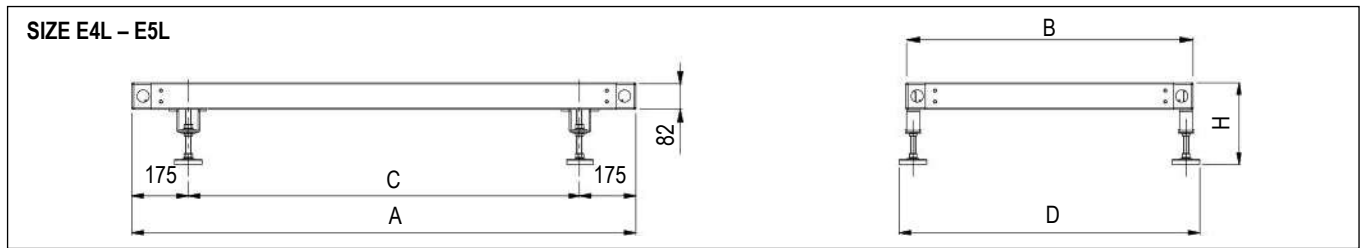
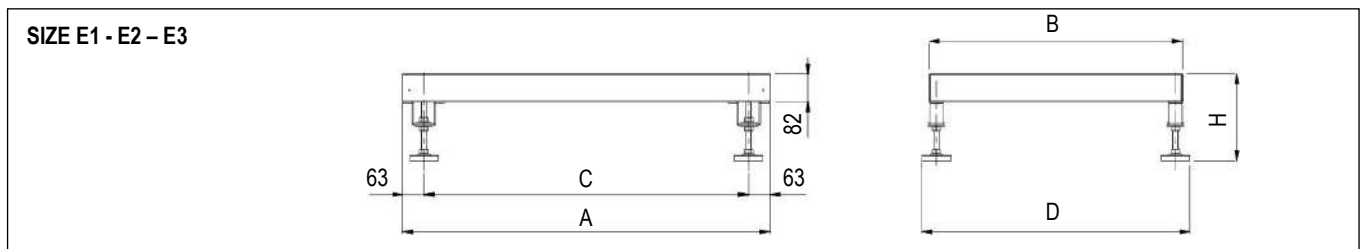

SIZE		E1	E2	E3	E4L	E5L	E6L	E7L	E8L	E9L
A	mm	650	785	1085	1630	1955	2198	2499	2899	3299
B	mm	650	650	750	905	905	905	905	905	905
C	mm	524	659	959	1280	1605	924	1074,5	1274,5	1474,5
D	mm	691	691	791	945	945	945	945	945	945

MODEL		P041 - Hmax350	P042 - Hmax450	P043 - Hmax510
H min height	mm	255	355	400
H max height	mm	350	450	510

**OPTIONAL ACCESSORIES: 3601 – COMPRESSOR OPERATING SIGNAL CONTACT**

A voltage free electrical contact is supplied for remote signalling "Compressor operation".  
Electrical connection on the machine's terminal board.

**OPTIONAL ACCESSORIES: 2411 – PHASE SEQUENCE RELAY**



The system checks that the phase sequence of the power supply is correct to prevent the opposite rotation of the three phase electric motors of the machine as compressors. The optional is installed in the electrical box downstream the main switch with door lock safety and in case of wrong phase sequence prevents starting the machine.

**OPTIONAL ACCESSORIES: 1511 – SOFT STARTER**



The optional is not available for size E1, E2. Compressor motors soft-starter system. The system is contained in the electrical box. Its function is to reduce the starting current of the motor with a monitored start.

The reduction of the starting current produced by soft starter optional accessory reduces the stress on the power line and on the compressors contributing to increase the components lifetime.

VERSION (1)		U / O	U / O	U / O	U / O	U / O	U / O
<b>MODEL</b>		<b>007 P1 S</b>	<b>009 P1 S</b>	<b>011 P1 S</b>	<b>014 P1 S</b>	<b>016 P1 S</b>	<b>020 P1 S</b>
<b>SIZE</b>		<b>E1</b>	<b>E1</b>	<b>E1</b>	<b>E2</b>	<b>E2</b>	<b>E3</b>
<b>ON/OFF COMPRESSORS</b>		-	-	-	-	-	scroll
Compressors number	#	-	-	-	-	-	1
Total starting current [LRA]	A	-	-	-	-	-	64
<b>WITH SOFT STARTER</b>							
Total starting current [LRA]	A	-	-	-	-	-	37

VERSION (1)		U / O	U / O	U / O	U / O	U / O	U / O
<b>MODEL</b>		<b>022 P1 S</b>	<b>026 P1 S</b>	<b>032 P1 S</b>	<b>037 P1 S</b>	<b>041 P1 S</b>	<b>045 P1 S</b>
<b>SIZE</b>		<b>E3</b>	<b>E3</b>	<b>E4L</b>	<b>E4L</b>	<b>E4L</b>	<b>E4L</b>
<b>ON/OFF COMPRESSORS</b>		scroll	scroll	scroll	scroll	scroll	scroll
Compressors number	#	1	1	1	1	1	1
Total starting current [LRA]	A	75	101	128	139	118	140
<b>WITH SOFT STARTER</b>							
Total starting current [LRA]	A	47	51	57	67	79	97

VERSION (1)		U / O	U / O	U / O	U / O	U / O	U / O
<b>MODEL</b>		<b>039 P2 D</b>	<b>048 P2 D</b>	<b>055 P2 D</b>	<b>062 P2 D</b>	<b>075 P2 D</b>	<b>082 P2 D</b>
<b>SIZE</b>		<b>E5L</b>	<b>E5L</b>	<b>E6L</b>	<b>E6L</b>	<b>E7L</b>	<b>E7L</b>
<b>ON/OFF COMPRESSORS</b>		scroll	scroll	scroll	scroll	scroll	scroll
Compressors number	#	2	2	2	2	2	2
Total starting current [LRA]	A	76	90	117	146	161	143
<b>WITH SOFT STARTER</b>							
Total starting current [LRA]	A	50	63	69	78	94	107

VERSION (1)		U / O	U / O	U	U
<b>MODEL</b>		<b>092 P2 D</b>	<b>102 P2 D</b>	<b>117 P4 D</b>	<b>146 P4 D</b>
<b>SIZE</b>		<b>E8L</b>	<b>E8L</b>	<b>E9L</b>	<b>E9L</b>
<b>ON/OFF COMPRESSORS</b>		scroll	scroll	scroll	scroll
Compressors number	#	2	2	4	4
Total starting current [LRA]	A	171	208	183	193
<b>WITH SOFT STARTER</b>					
Total starting current [LRA]	A	131	143	131	150

1. U = Under, downflow / O = Over, upflow

### OPTIONAL ACCESSORIES: 3301 – COMPRESSOR REPHASING

Compressors capacitor for power factor -  $\cos\phi$  0,9 (sizes E1, E2 excluded).

### OPTIONAL ACCESSORIES: A181 – COMPRESSOR SOUNDPROOF JACKET



A soundproof jacket for each compressor to obtain a reduction of the sound level of the unit.

### OPTIONAL ACCESSORIES: A272 – CL.0 or A1 (EN13501-1) INSULATION

The optional is designed **TO SUPPLY THE PANELING ONLY WITH FIRE REACTION IN CLASS “0” OR “A1 (EN 13501-1)”**; furthermore allows a noise insulation of the panels of the air conditioners. The pressure level reduction of the unit is about 2 dB(A). The reduction refers **ONLY** to the sound level radiated from the unit or in front of the unit. The noise level data on return and delivery air do not undergo reductions.

The accessory includes:

- External part as standard panel.
- Internal part in galvanized steel sheet.
- The inside noise insulation with special soundproof material.

#### REACTION TO FIRE CLASSIFICATION

On Italian territory, the classification is per the D.M. of June 26, 1984 and subsequent amendments, providing for a sort in "Classes" from 0 (non-combustible material) to 5 (extremely flammable material). The EN 13501-1 regulation is ordered in classes from A1 (non-combustible material) to F (extremely flammable material).

A comparison of the classes is not possible because the methods and evaluation criteria are completely different. The comparison table below is being considered purely indicative.

Definition	Italian classes	EN 13501-1
Non-combustible material	Class 0	A1
Combustible material, very limited contribution to fire	Class 1	A2 – B
Combustible material, limited contribution to fire	Class 2	A2 – B - C
Combustible material, medium contribution to fire	Class 3	C – D
Combustible material, highly contribution to fire	Class 4	E
Combustible material, easily flammable	Class 5	F

Is possible to provide the sandwich panels for the OVER units with air flow from the top. This implies that the air intake must necessarily be from the base of the unit with front blind paneling. The accessory increases the unit weight:

OVER										
SIZE		E1	E2	E3	E4L	E5L	E6L	E7L	E8L	E9L
Weight increasing (1)	kg	26	42	48	64	72	86	100	115	--

UNDER										
SIZE		E1	E2	E3	E4L	E5L	E6L	E7L	E8L	E9L
Weight increasing (1)	kg	30	48	55	70	86	110	130	145	165

1. Add this value to the total unit weight

### OPTIONAL ACCESSORIES: P151 – LOWERED DISPLAY FOR UNDER

For machines installed above the supply plenum. The display / keypad on the front panel of the machine is installed lowered by about 50cm to facilitate consultation and use.

MACHINE DRAWINGS

Dimensions in mm – UNDER E1

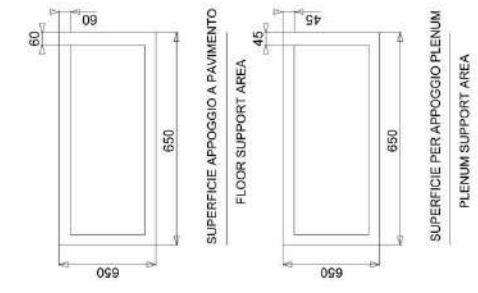

\* CON SERRANDA DI NON RITORNO  
ALTEZZA TOTALE = 2095

\* WITH NON RETURN MOTORIZED DAMPER  
TOTAL HEIGHT = 2095

CONNESSIONI / CONNECTIONS	
15	USCITA ACQUA FREDDA FREED COOLING WATER OUTLET R.1
14	USCITA ACQUA FREDDA FREED COOLING WATER OUTLET R.2
13	USCITA ACQUA DUAL FLUID SYSTEM R.1
12	USCITA ACQUA DUAL FLUID SYSTEM R.2
11	USCITA ACQUA DUAL FLUID SYSTEM R.3
10	USCITA ACQUA DUAL FLUID SYSTEM R.4
9	USCITA ACQUA CONDENSATORE R.1
8	USCITA ACQUA CONDENSATORE R.2
7	USCITA ACQUA CONDENSATORE R.3
6	USCITA ACQUA CONDENSATORE R.4
5	ALIMENTAZIONE ELETTRICA POWER SUPPLY
4	SCARICO ACQUA CONDENSATORE R.1 HUMIDIFIER DRAIN R.1
3	SCARICO ACQUA CONDENSATORE R.2 HUMIDIFIER DRAIN R.2

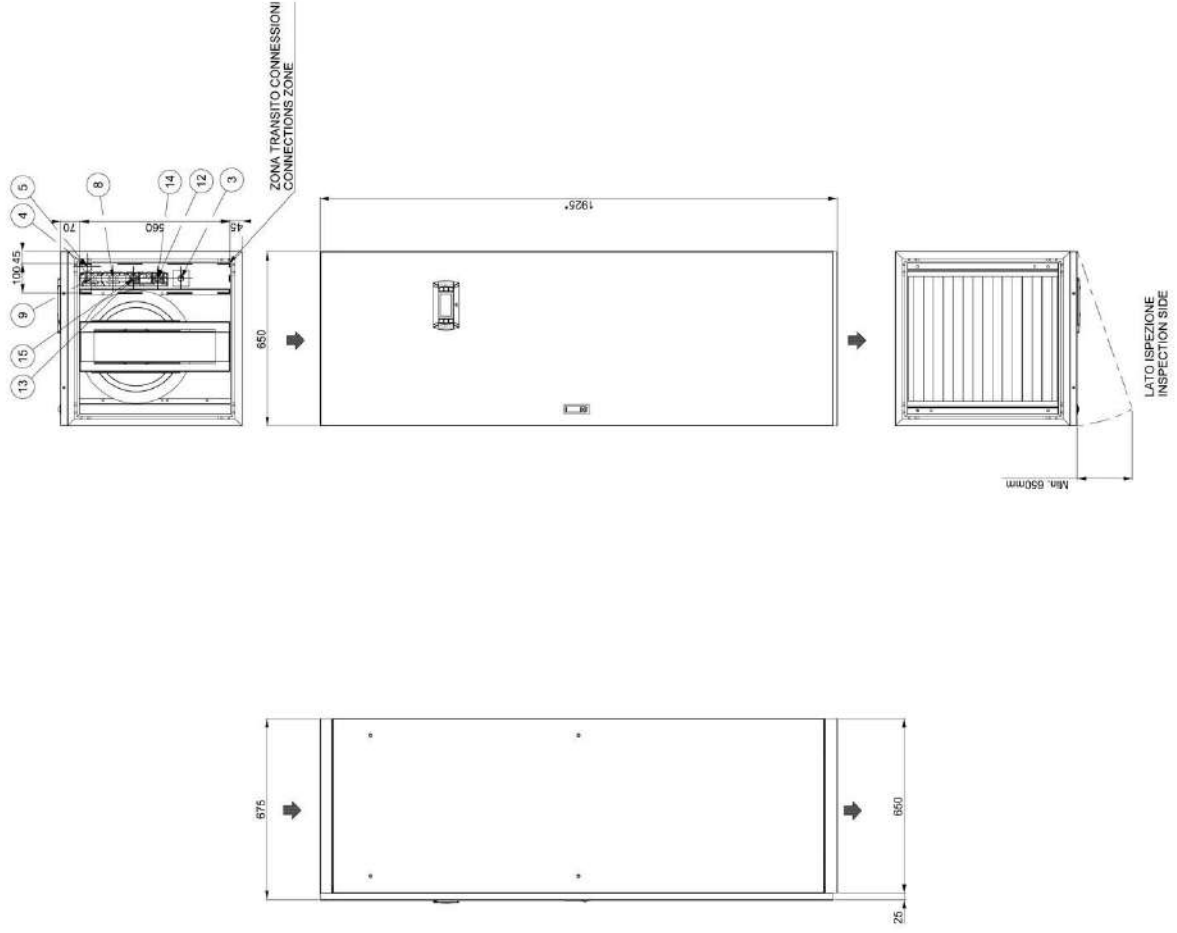



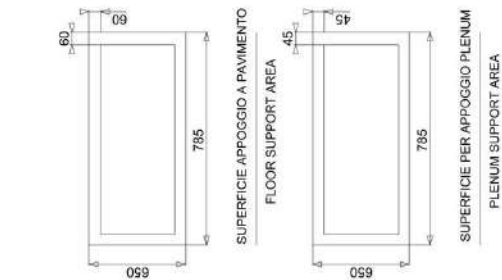

\* CON SERRANDA DI NON RITORNO  
ALTEZZA TOTALE = 2095

\* WITH NON RETURN MOTORIZED DAMPER  
TOTAL HEIGHT = 2095

CONNESSIONI / CONNECTIONS	
15	USCITA ACQUA FREDE COOLING R.1
14	USCITA ACQUA FREDE COOLING R.2
13	USCITA ACQUA DUAL FLUID SYSTEM R.1
12	USCITA ACQUA DUAL FLUID SYSTEM R.2
9	USCITA ACQUA CONDENSATORE R.1
8	USCITA ACQUA CONDENSATORE R.2
5	ALIMENTAZIONE ELETTRICA
4	SCARICO ACQUA CONDENSATORE Ø 19mm
3	SCARICO CONDENSATO Ø 19mm
	CONDENSATE DISCHARGE Ø 19mm

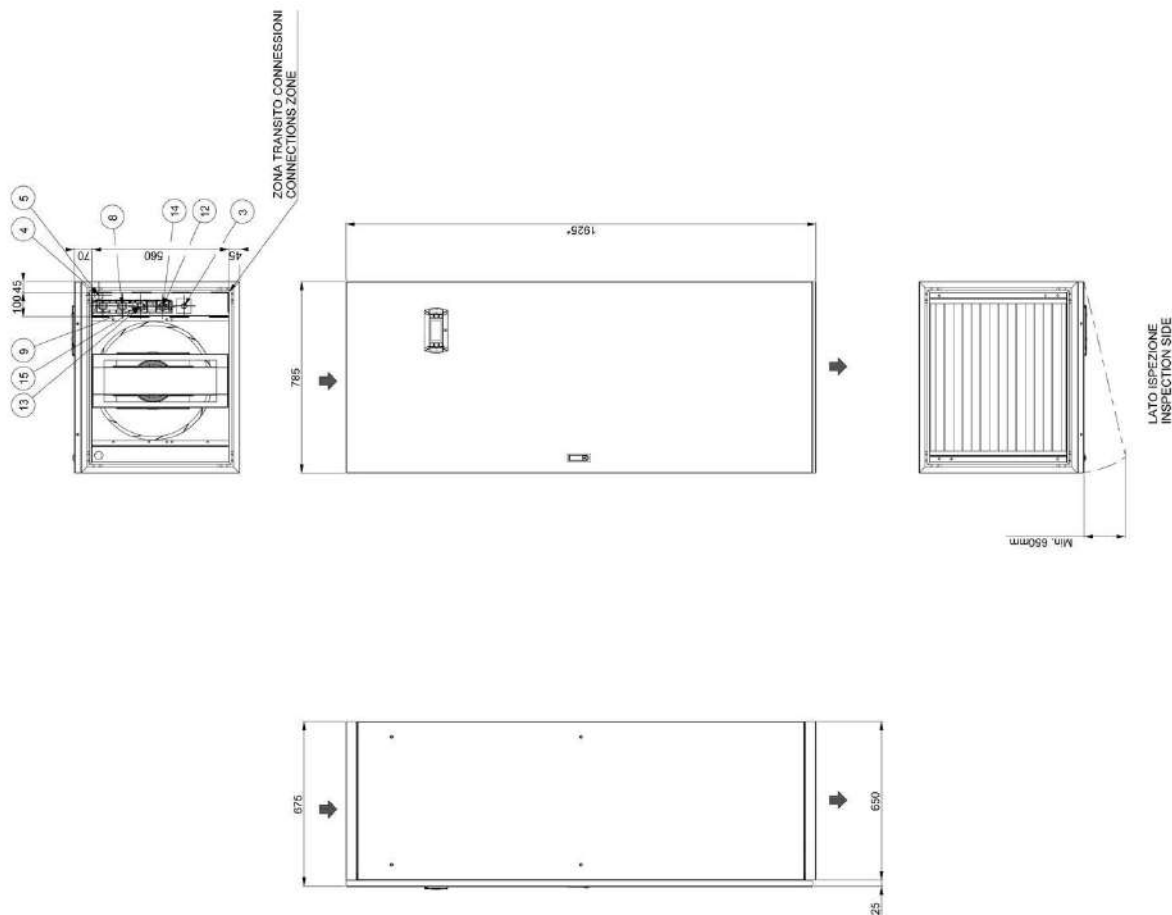

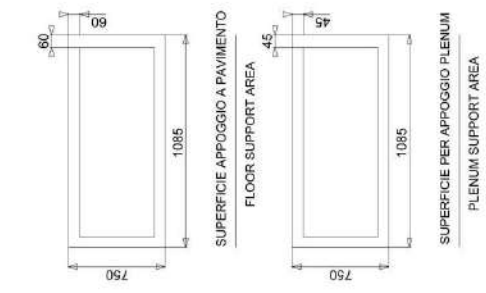

- \* CON SERRANDA DI NON RITORNO  
ALTEZZA TOTALE = 2095
- \* WITH NON RETURN MOTORIZED DAMPER  
TOTAL HEIGHT = 2095

CONNESSIONI / CONNECTIONS	
15	USCITA ACQUA FREDDA FREES COOLING R.T. 1/4"
14	USCITA ACQUA FREDDA FREES COOLING R.T. 1/4"
13	USCITA ACQUA DALLA FLUID SYSTEM T. 1/4"
12	USCITA ACQUA DALLA FLUID SYSTEM T. 1/4"
9	USCITA ACQUA CONDENSATORE R.T. 1/4"
8	USCITA ACQUA CONDENSATORE R.T. 1/4"
5	ALIMENTAZIONE ELETTRICA
4	SCARICO ACQUA LAMBRICAZIONE 3/8"
3	SCARICO CONDENSATO 3/8"

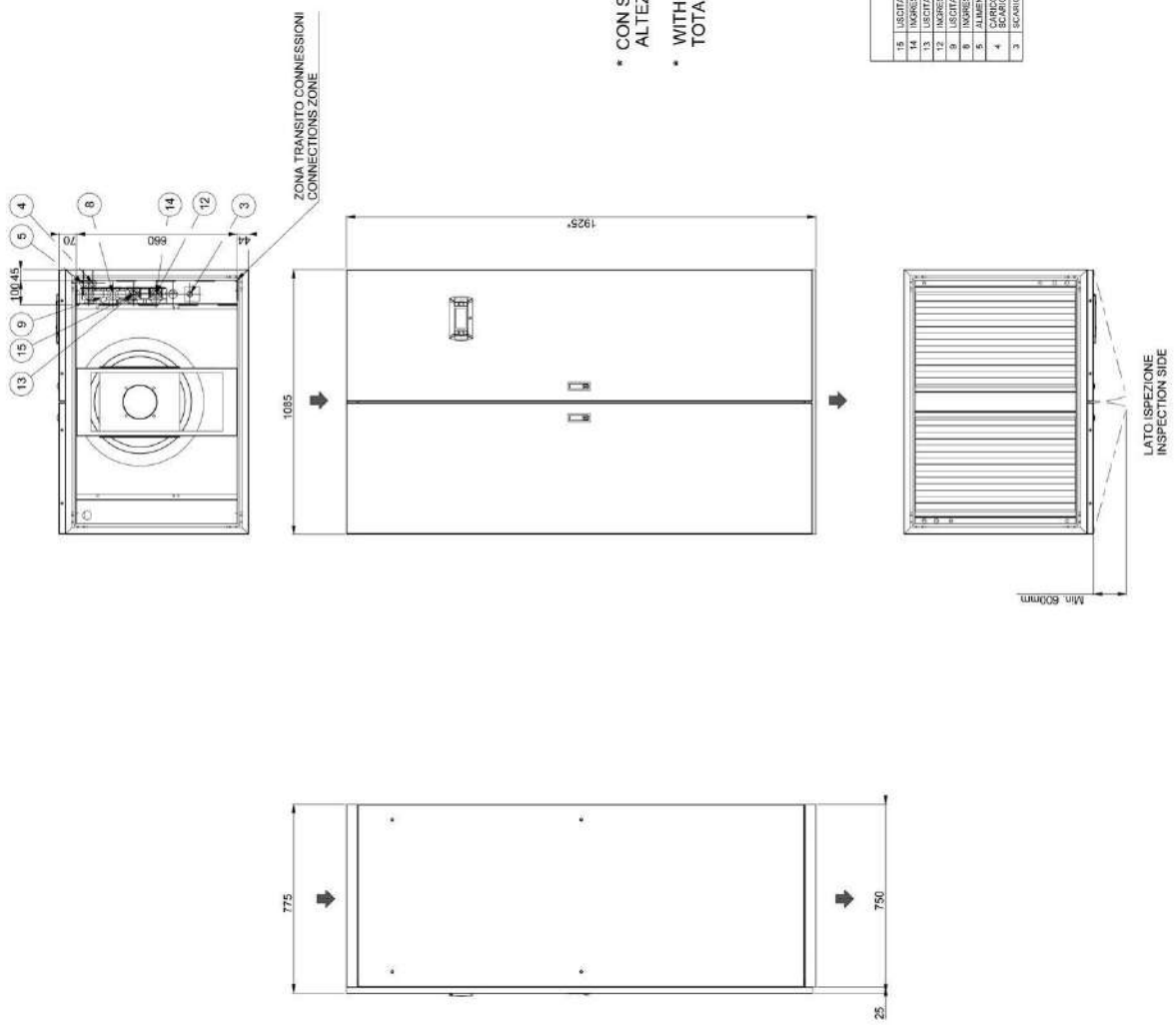

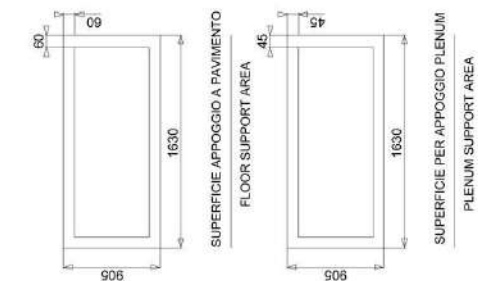

\* CON SERRANDA DI NON RITORNO  
ALTEZZA TOTALE = 2150

\* WITH NON RETURN MOTORIZED DAMPER  
TOTAL HEIGHT = 2150

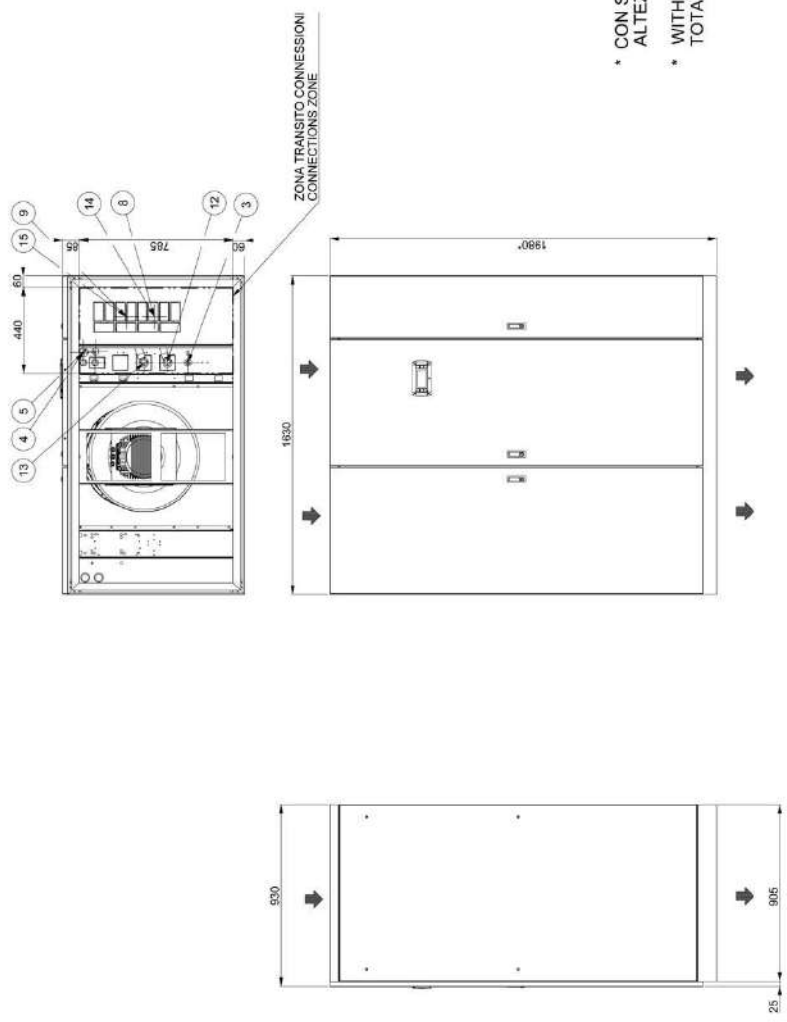

CONNESSIONI / CONNECTIONS	
15	USCITA ACQUA FREE-COOLING R1 1/2
14	INGRESSO ACQUA FREE-COOLING R1 1/2
13	USCITA ACQUA FREE-COOLING R1 1/2
12	INGRESSO ACQUA DALLI FLUID SYSTEM R1 1/2
9	USCITA ACQUA CONDENSATORE R1 1/2
8	INGRESSO ACQUA CONDENSATORE R1 1/2
5	ALIMENTAZIONE ELETTRICA
4	SCARICO ACQUA UMIDIFICATORE Ø 19mm
3	SCARICO CONDENSATO Ø 19mm
	FREE COOLING WATER OUTLET R1 1/2
	FREE COOLING WATER INLET R1 1/2
	FREE COOLING WATER OUTLET R1 1/2
	DUAL FLUID SYSTEM INLET R1 1/2
	DUAL FLUID SYSTEM INLET R1 1/2
	WATER CONDENSER OUTLET R1 1/2
	WATER CONDENSER INLET R1 1/2
	POWER SUPPLY
	HUMIDIFIER DRAIN Ø 19mm
	CONDENSATE DISCHARGE Ø 19mm

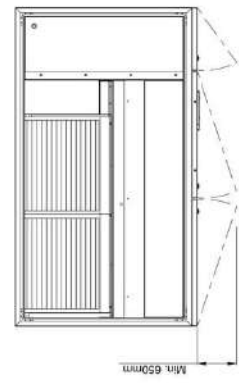

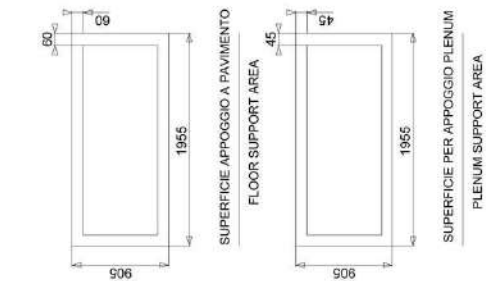

\* CON SERRANDA DI NON RITORNO  
ALTEZZA TOTALE = 2150

\* WITH NON RETURN MOTORIZED DAMPER  
TOTAL HEIGHT = 2150

CONNESSIONI / CONNECTIONS	
15	USCITA ACQUA FREDDA FREES COOLING R2
14	USCITA ACQUA FREDDA DAL FLUID SYSTEM R2
13	USCITA ACQUA CALDA DAL FLUID SYSTEM R2
12	INGRESSO ACQUA CALDA DAL FLUID SYSTEM R2
9	USCITA ACQUA CONDENSATORE R2
8	INGRESSO ACQUA CONDENSATORE R2
5	ALIMENTAZIONE ELETTRICA
4	SCARICO ACQUA CONDENSATORE 1/2" Ø
3	SCARICO ACQUA CONDENSATORE 1/2" Ø

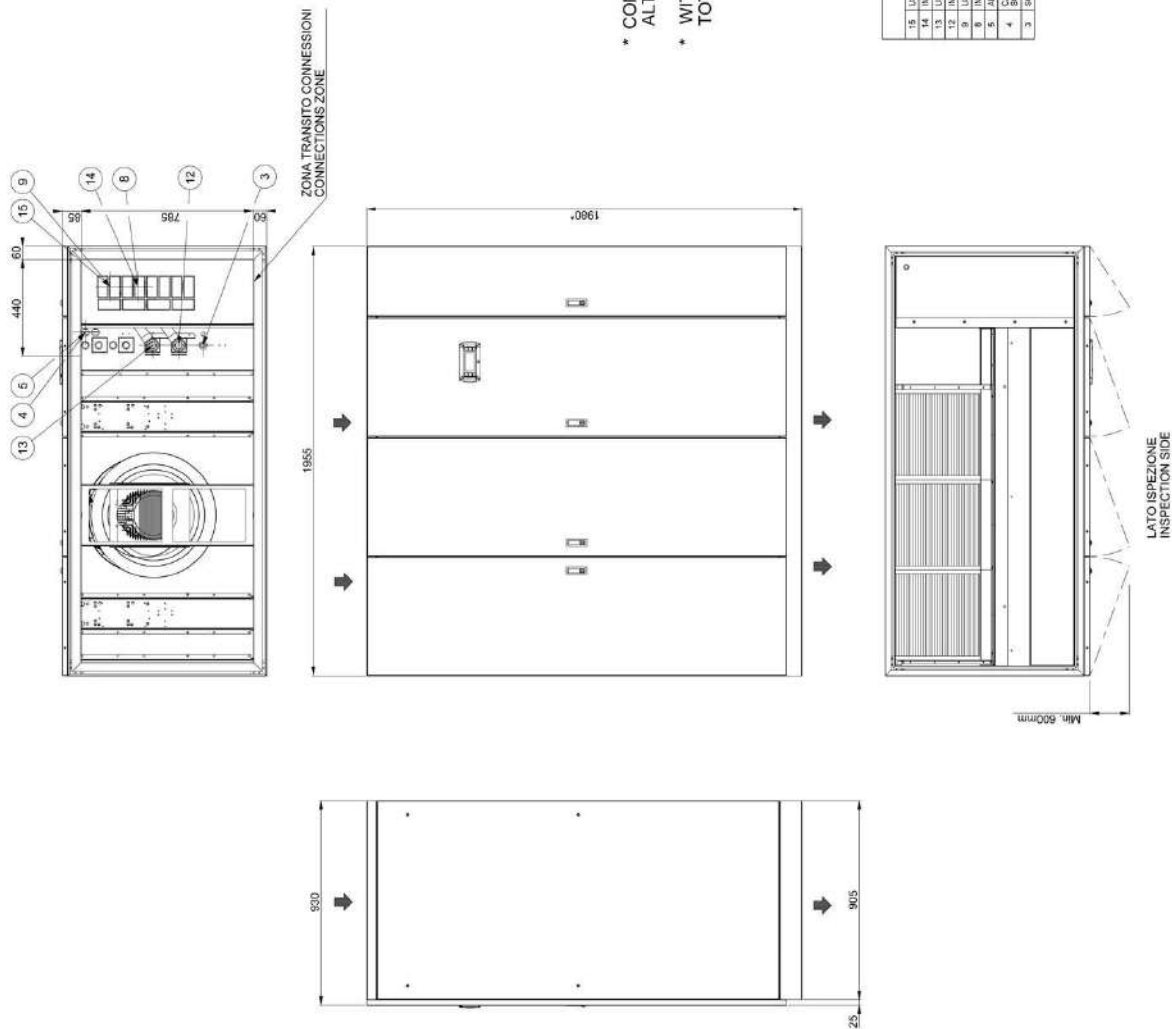

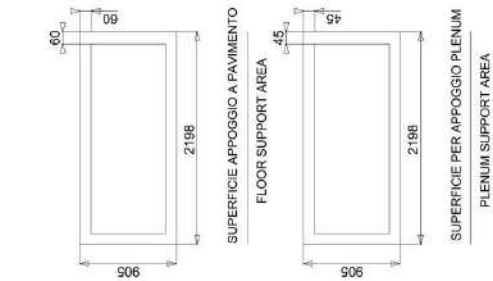

- \* CON SERRANDA DI NON RITORNO  
ALTEZZA TOTALE = 2150
- \* WITH NON RETURN MOTORIZED DAMPER  
TOTAL HEIGHT= 2150

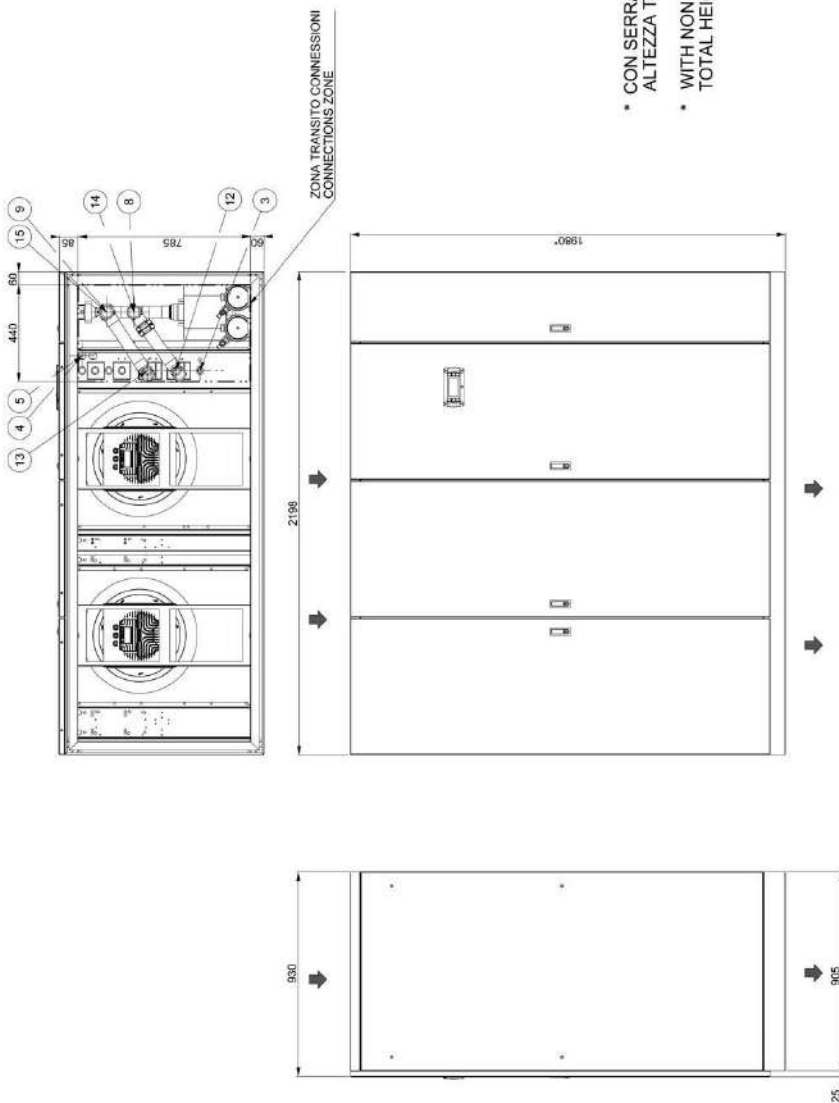

CONNESSIONI / CONNECTIONS	
15	USCITA ACQUA FREDDA (COOLING R2)
14	USCITA ACQUA FREDDA (COOLING R2)
13	USCITA ACQUA FREDDA (COOLING R2)
12	INGRESSO ACQUA DALLA FLUID SYSTEM R2
9	USCITA ACQUA CONDENSATORE R2
8	INGRESSO ACQUA CONDENSATORE R2
5	ALIMENTAZIONE ELETTRICA
4	SCARICO ACQUA CONDENSATORE R2
3	SCARICO CONDENSATE R2
	FREE COOLING WATER OUTLET R2
	FREE COOLING WATER INLET R2
	DUAL FLUID SYSTEM INLET R2
	DUAL FLUID SYSTEM OUTLET R2
	WATER CONDENSER OUTLET R2
	WATER CONDENSER INLET R2
	POWER SUPPLY
	CONDENSATE DRAIN R2
	HUMIDIFIER DRAIN R2
	CONDENSATE DISCHARGE R2

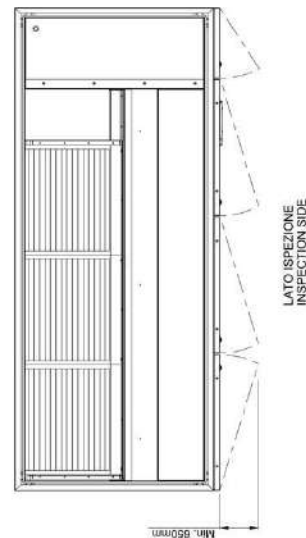

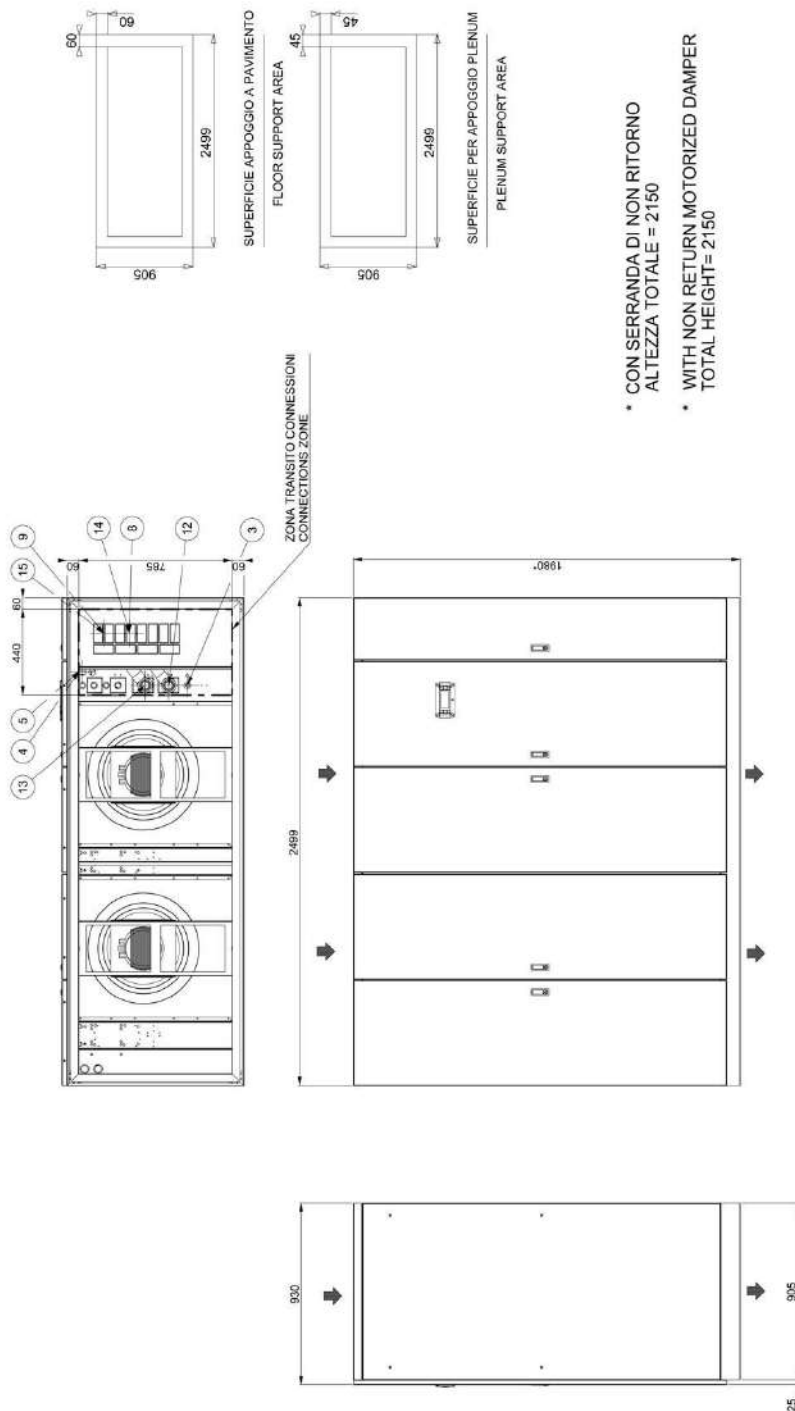

- \* CON SERRANDA DI NON RITORNO  
ALTEZZA TOTALE = 2150
- \* WITH NON RETURN MOTORIZED DAMPER  
TOTAL HEIGHT = 2150

CONNESSIONI / CONNECTIONS
15 USCITA ACQUA FREDDA COOLING R2 1/2
14 USCITA ACQUA FREDDA COOLING R2 1/2
13 USCITA ACQUA FREDDA COOLING R2 1/2
12 INGRESSO ACQUA DALLA FLUID SYSTEM R2 1/2
9 USCITA ACQUA CONDENSATORE R2 1/2
8 INGRESSO ACQUA CONDENSATORE R2 1/2
5 ALIMENTAZIONE ELETTRICA POWER SUPPLY
4 SCARICO ACQUA UMIDIFICATORE HUMIDIFIER DRAIN Ø 18mm
3 SCARICO CONDENSATE DISCHARGE Ø 18mm

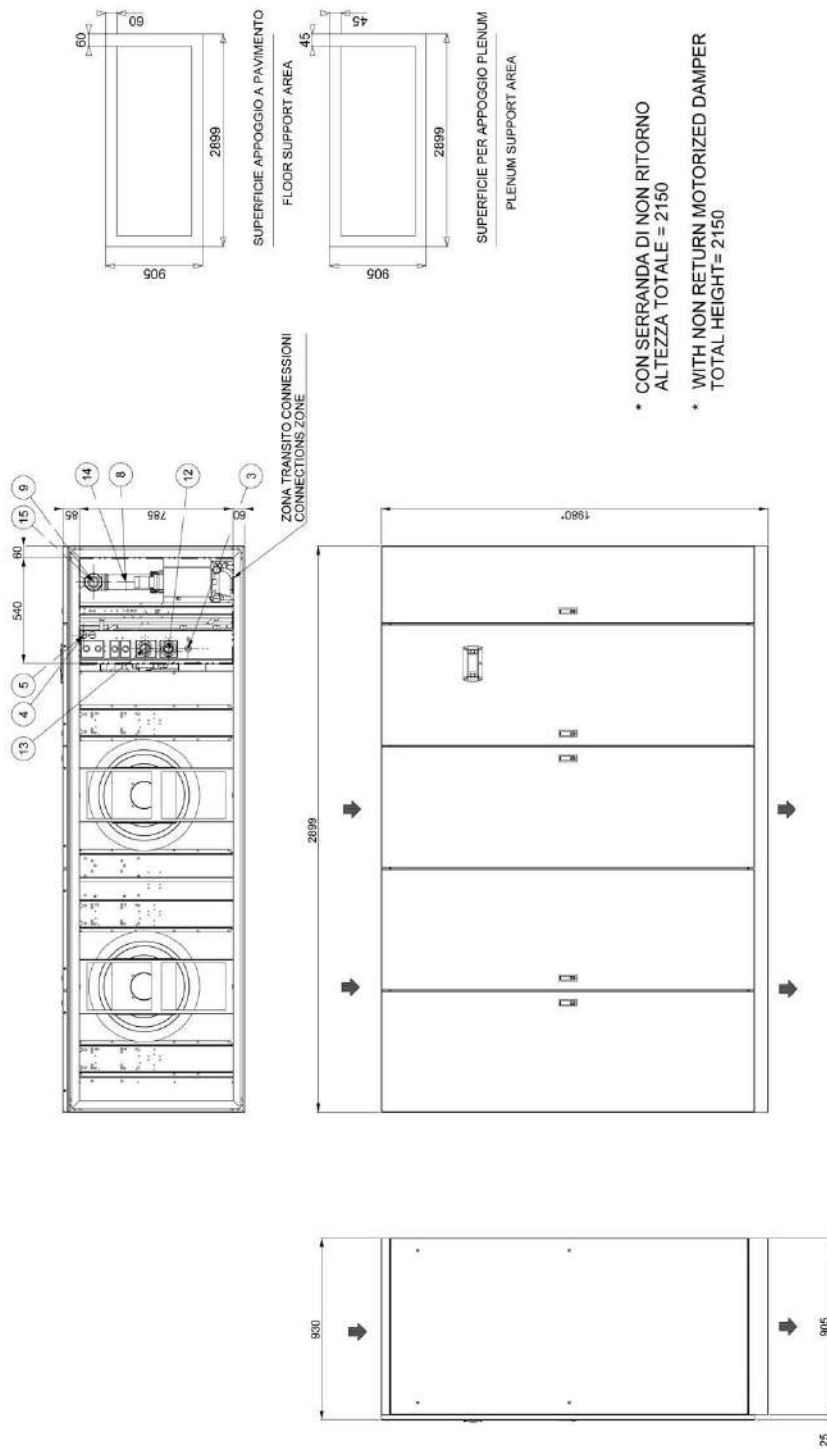

\* CON SERRANDA DI NON RITORNO  
ALTEZZA TOTALE = 2150

\* WITH NON RETURN MOTORIZED DAMPER  
TOTAL HEIGHT = 2150

CONNESSIONI / CONNECTIONS	
15	USCITA ACQUA FREDE COOLING R2 1/2
14	USCITA ACQUA FREDE COOLING R2 1/2
13	USCITA ACQUA CALDA FLUID SYSTEM R2 1/2
12	USCITA ACQUA CALDA FLUID SYSTEM R2 1/2
11	USCITA ACQUA CALDA FLUID SYSTEM R2 1/2
10	USCITA ACQUA CALDA FLUID SYSTEM R2 1/2
9	USCITA ACQUA CALDA FLUID SYSTEM R2 1/2
8	USCITA ACQUA CALDA FLUID SYSTEM R2 1/2
7	USCITA ACQUA CALDA FLUID SYSTEM R2 1/2
6	USCITA ACQUA CALDA FLUID SYSTEM R2 1/2
5	USCITA ACQUA CALDA FLUID SYSTEM R2 1/2
4	USCITA ACQUA CALDA FLUID SYSTEM R2 1/2
3	USCITA ACQUA CALDA FLUID SYSTEM R2 1/2

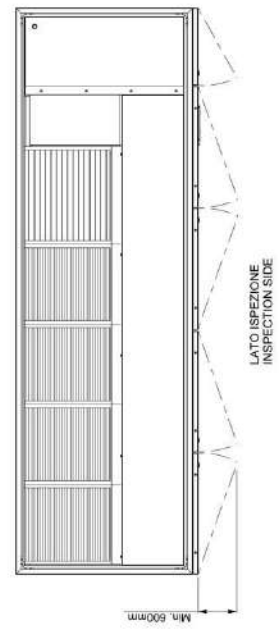

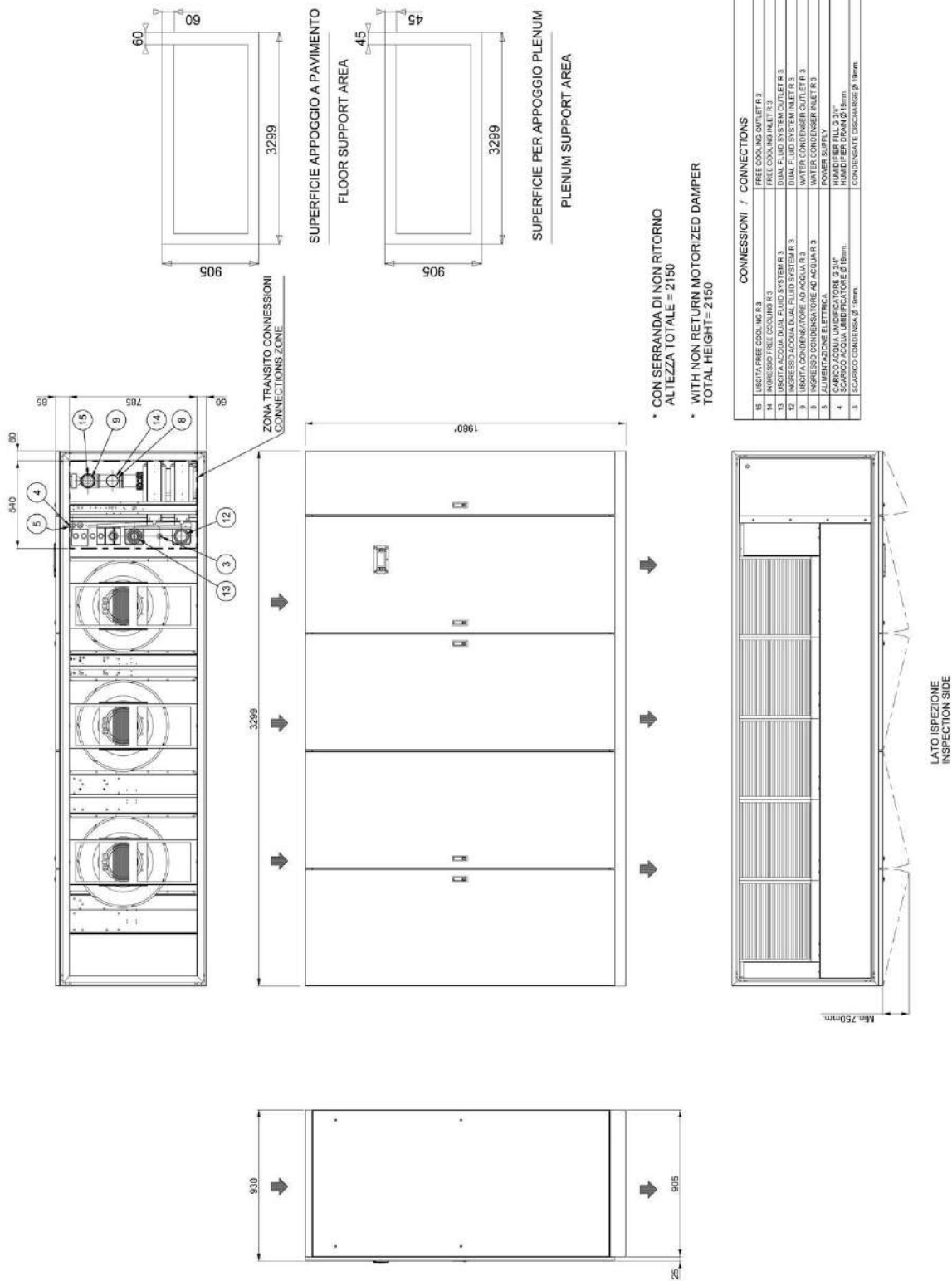





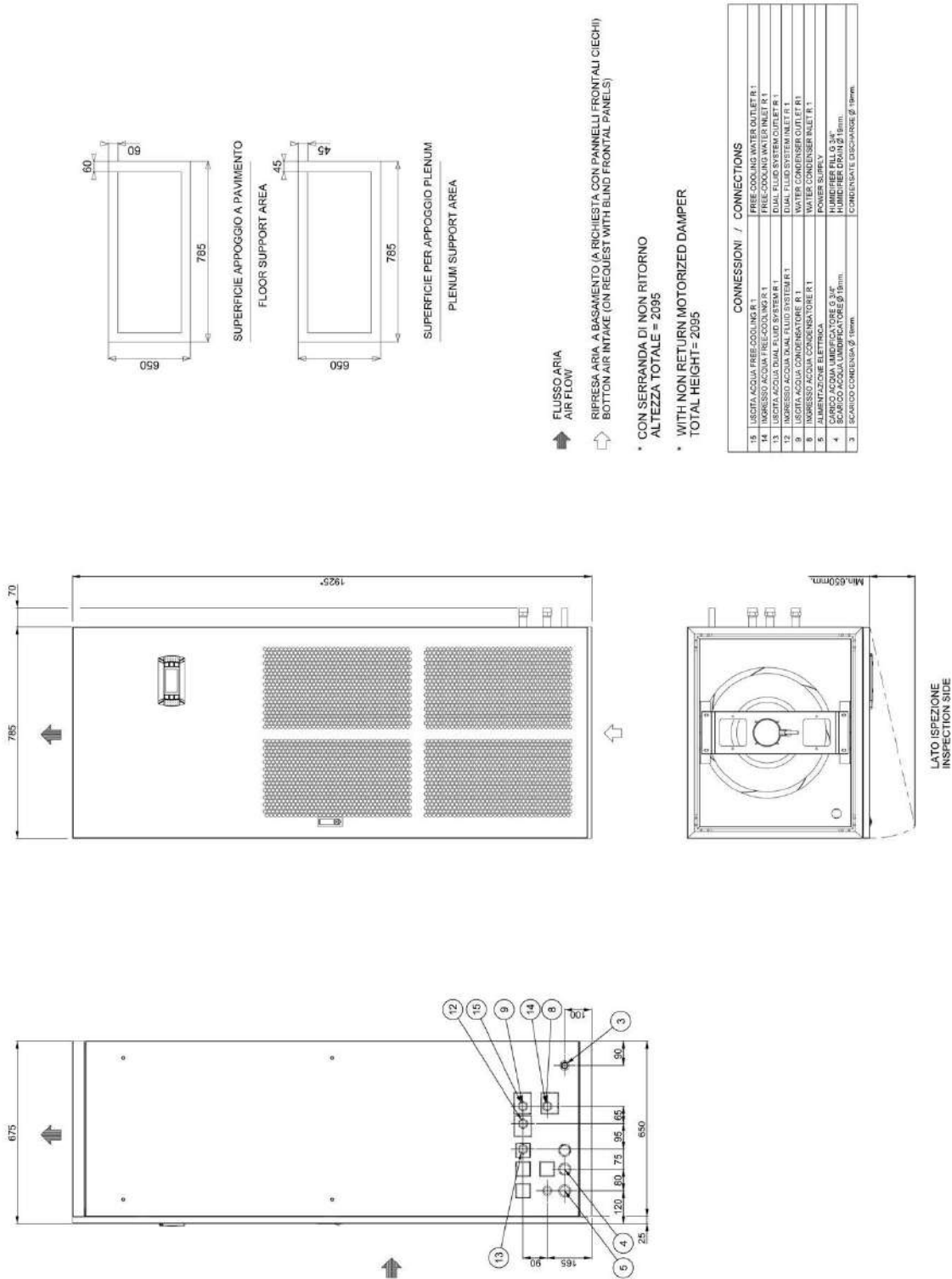

↑ FLUSSO ARIA / AIR FLOW  
 ↑ RIPRESA ARIA A BASAMENTO (A RICHIESTA CON PANNELLI FRONTALI CIECHI) / BOTTOM AIR INTAKE (ON REQUEST WITH BLIND FRONTAL PANELS)

\* CON SERRANDA DI NON RITORNO / WITH NON RETURN MOTORIZED DAMPER  
 ALTEZZA TOTALE = 2095 / TOTAL HEIGHT = 2095

CONNESSIONI / CONNECTIONS	
15	USCITA ACQUA FREDDA (COOLING WATER OUTLET R.1)
14	INGRESSO ACQUA FREDDA (COOLING WATER INLET R.1)
13	INGRESSO ACQUA FREDDA (COOLING WATER INLET R.2)
12	INGRESSO ACQUA DAL FLUIDO SYSTEM R.1 (DUAL FLUID SYSTEM INLET R.1)
9	USCITA ACQUA CONDENSATORE R.1 (WATER CONDENSER OUTLET R.1)
8	INGRESSO ACQUA CONDENSATORE R.1 (WATER CONDENSER INLET R.1)
5	ALIMENTAZIONE ELETTRICA (POWER SUPPLY)
4	SCARICO ACQUA UMIDIFICATORE R.1 (HUMIDIFIER DRAIN R.1)
3	SCARICO CONDENSATE (CONDENSATE DISCHARGE) Ø 19mm

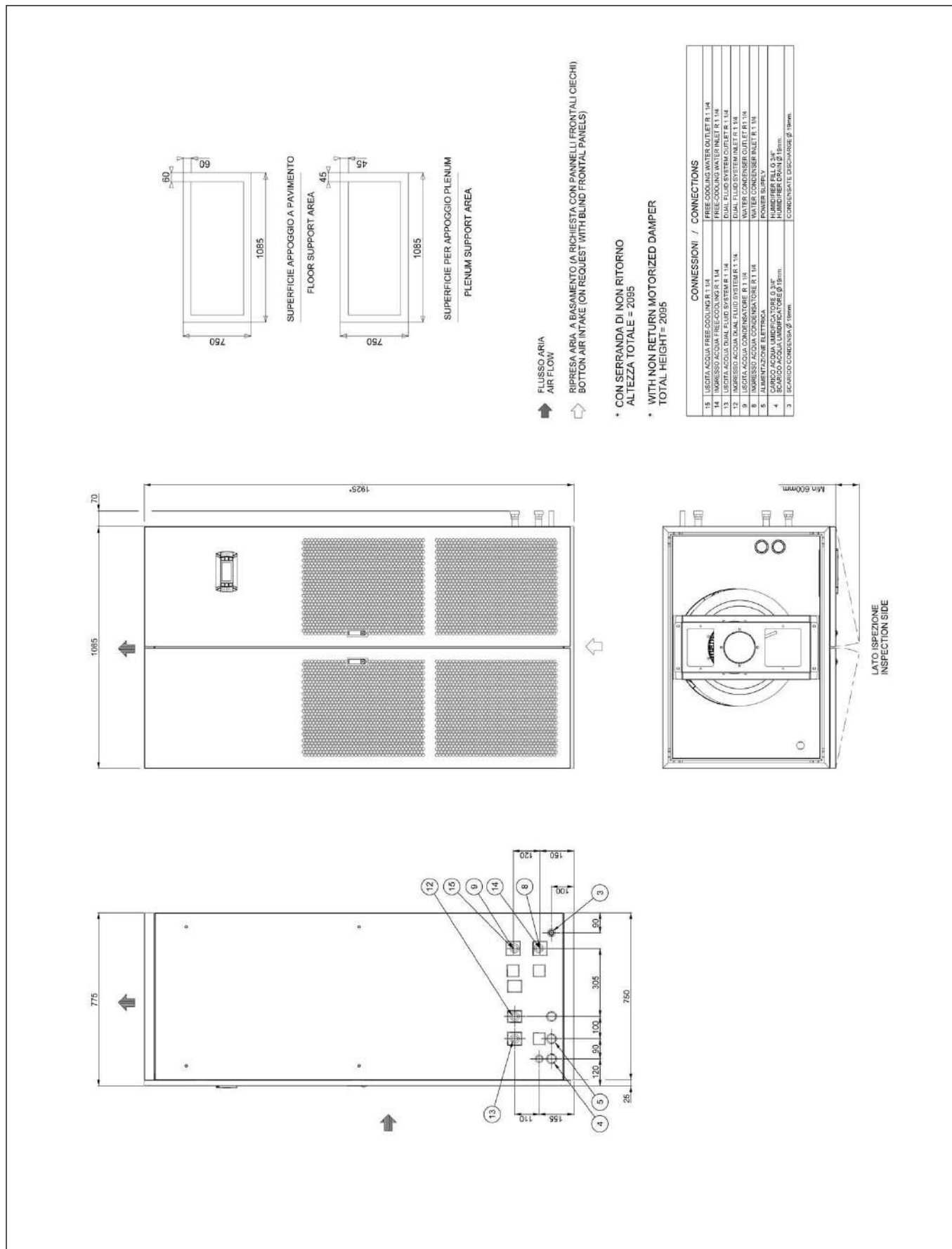

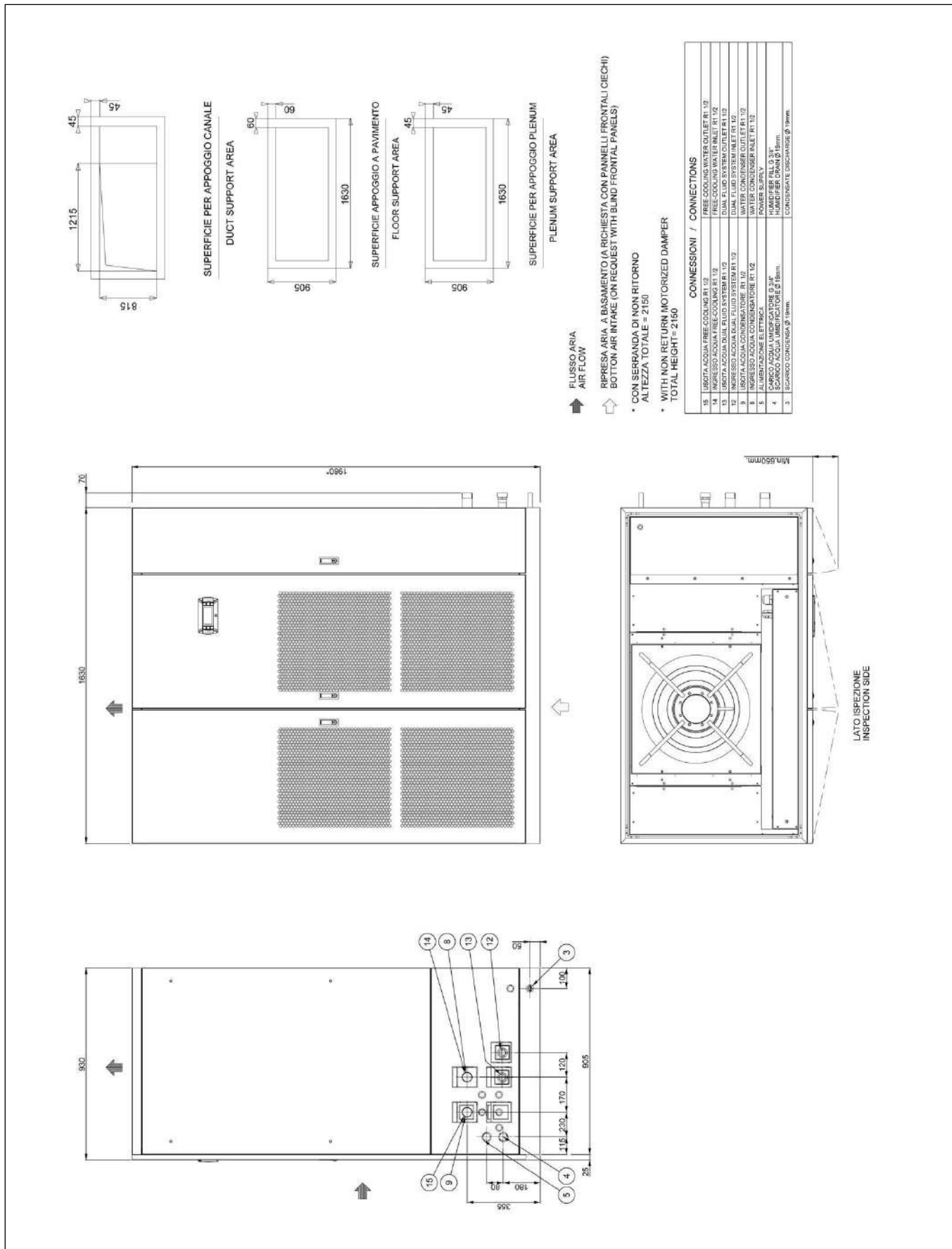

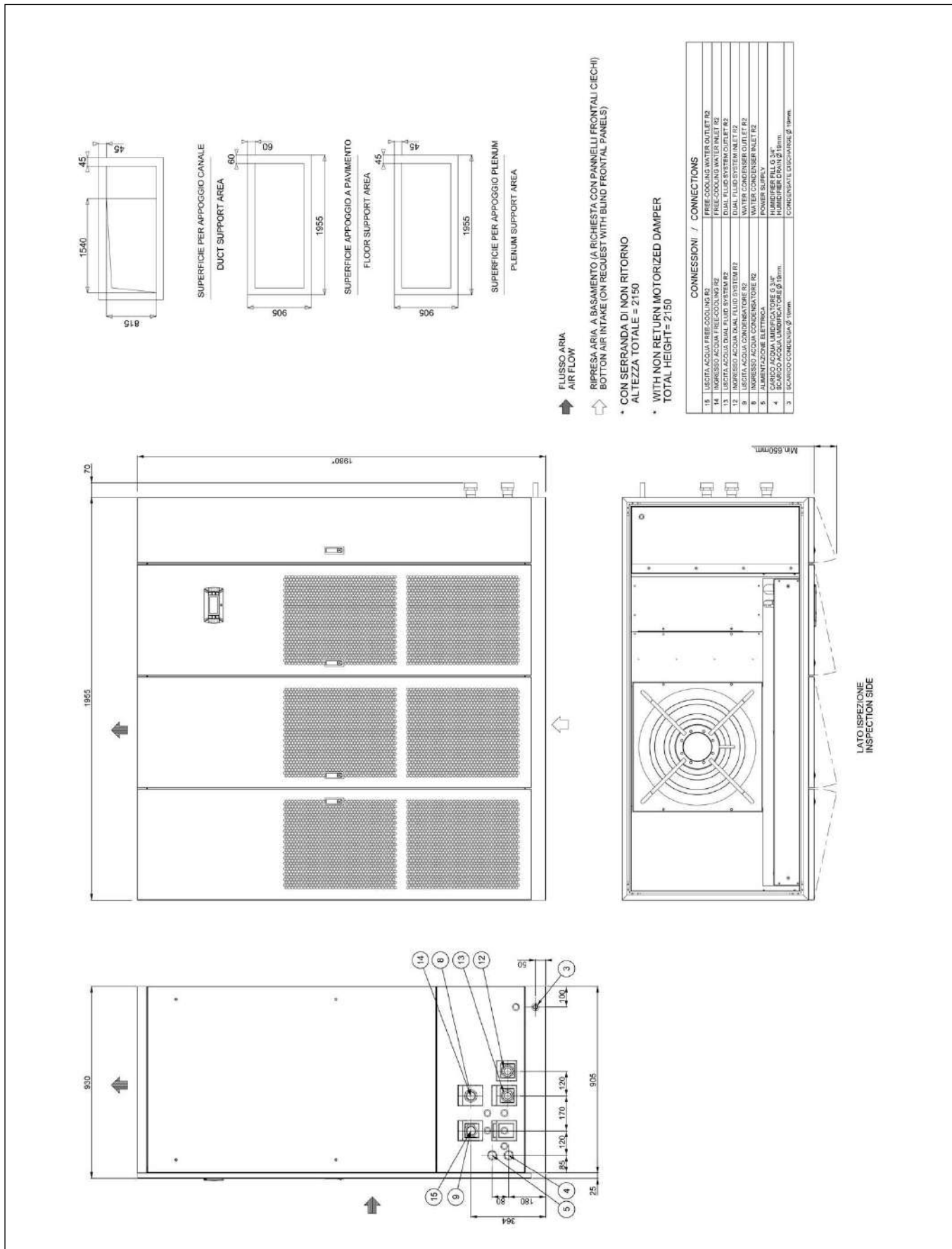

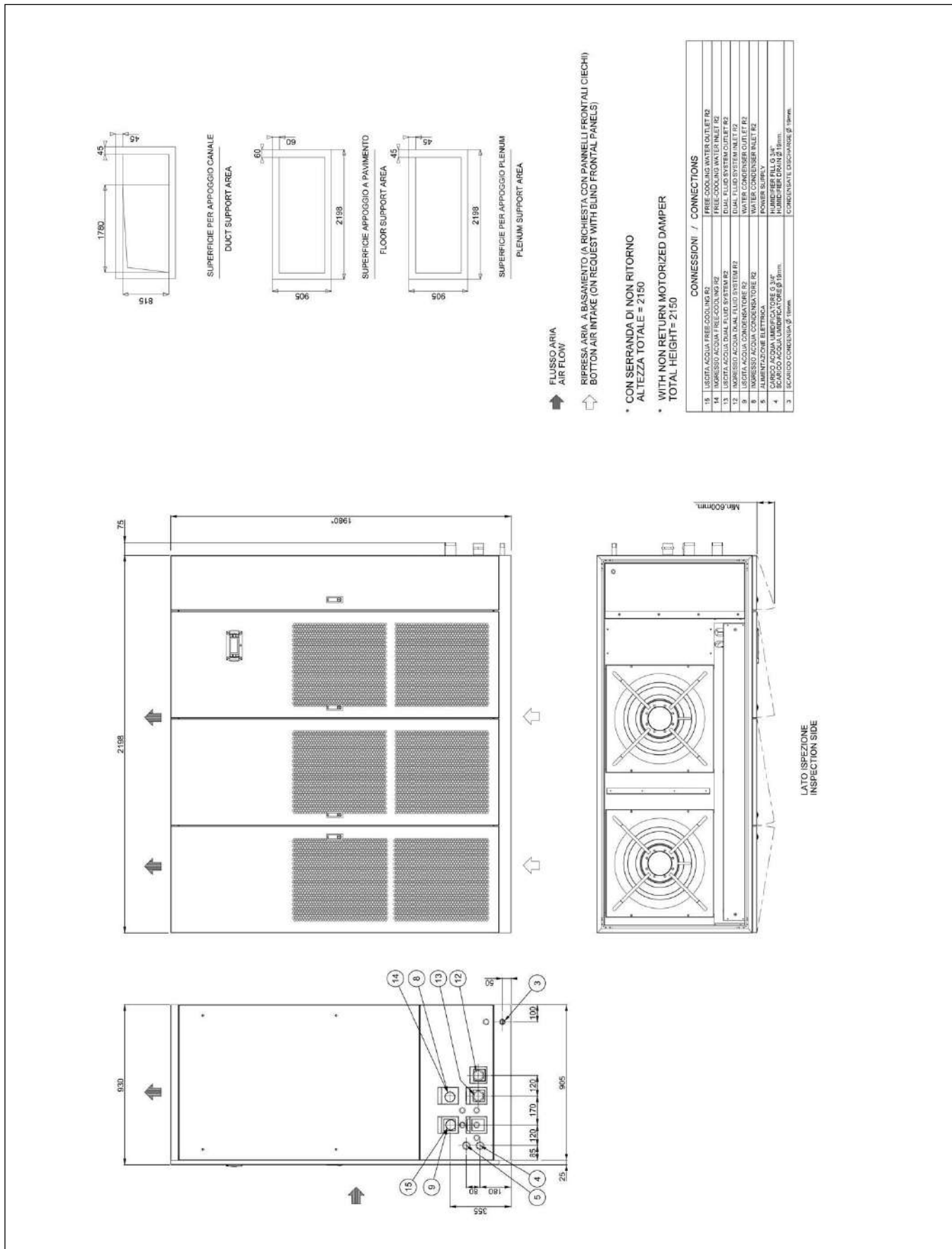

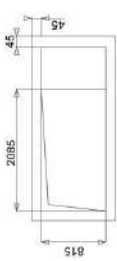

SUPERFICIE PER APPOGGIO CANALE  
DUCT SUPPORT AREA

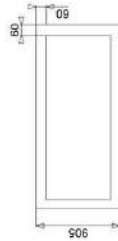

SUPERFICIE APPOGGIO A PAVIMENTO  
FLOOR SUPPORT AREA



SUPERFICIE PER APPOGGIO PLENUM  
PLENUM SUPPORT AREA

↑ FLUSSO ARIA  
AIR FLOW

↑ RIPRESA ARIA A BASAMENTO (A RICHIESTA CON PANNELLI FRONTALI CIECHI)  
BOTTOM AIR INTAKE (ON REQUEST WITH BLIND FRONTAL PANELS)

- CON SERRANDA DI NON RITORNO  
ALTEZZA TOTALE = 2150
- WITH NON RETURN MOTORIZED DAMPER  
TOTAL HEIGHT = 2150

CONNESSIONI / CONNECTIONS	
15. USCITA ACQUA FREE-COOLING R2 1/2	FREE-COOLING WATER OUTLET R2 1/2
14. INGRESSO ACQUA FREE-COOLING R2 1/2	FREE-COOLING WATER INLET R2 1/2
13. USCITA ACQUA DUAL FLUID SYSTEM R2 1/2	DUAL FLUID SYSTEM OUTLET R2 1/2
12. INGRESSO ACQUA DUAL FLUID SYSTEM R2 1/2	DUAL FLUID SYSTEM INLET R2 1/2
11. USCITA ACQUA FREE-COOLING R2 1/2	FREE-COOLING WATER OUTLET R2 1/2
10. INGRESSO ACQUA FREE-COOLING R2 1/2	FREE-COOLING WATER INLET R2 1/2
9. USCITA ACQUA CONDENSATORE R2 1/2	CONDENSER WATER OUTLET R2 1/2
8. INGRESSO ACQUA CONDENSATORE R2 1/2	CONDENSER WATER INLET R2 1/2
7. ALIMENTAZIONE ELETTRICA	POWER SUPPLY
6. CARICO ACQUA UMIDIFICATORE Ø 3/4"	HUMIDIFIER FILL Ø 3/4"
5. SCARICO ACQUA UMIDIFICATORE Ø 18mm	HUMIDIFIER DRAIN Ø 18mm
4. SCARICO CONDENSATA Ø 18mm	CONDENSATE DRAINAGE Ø 18mm

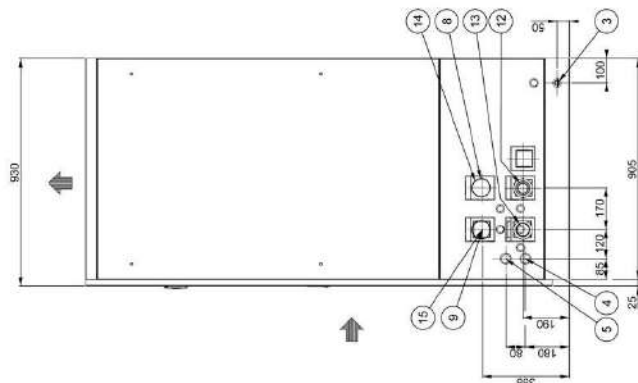
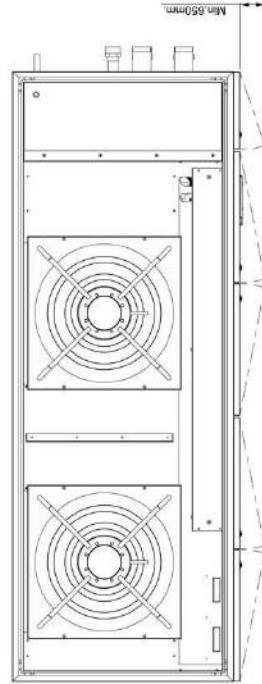
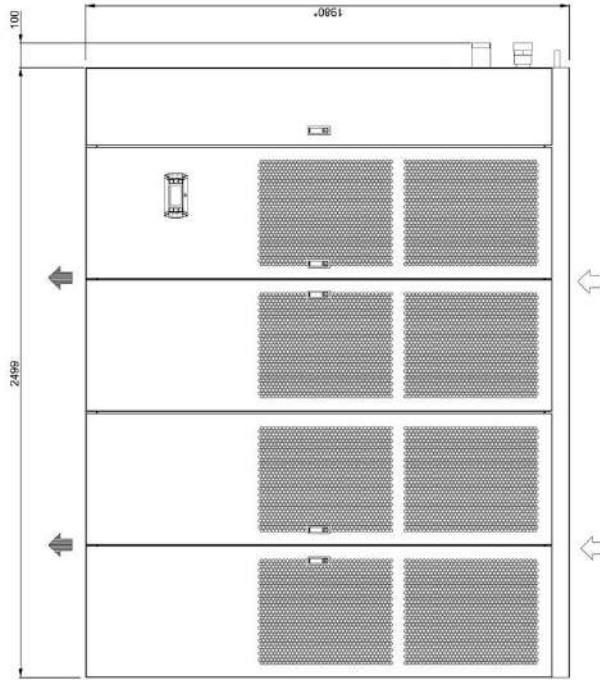

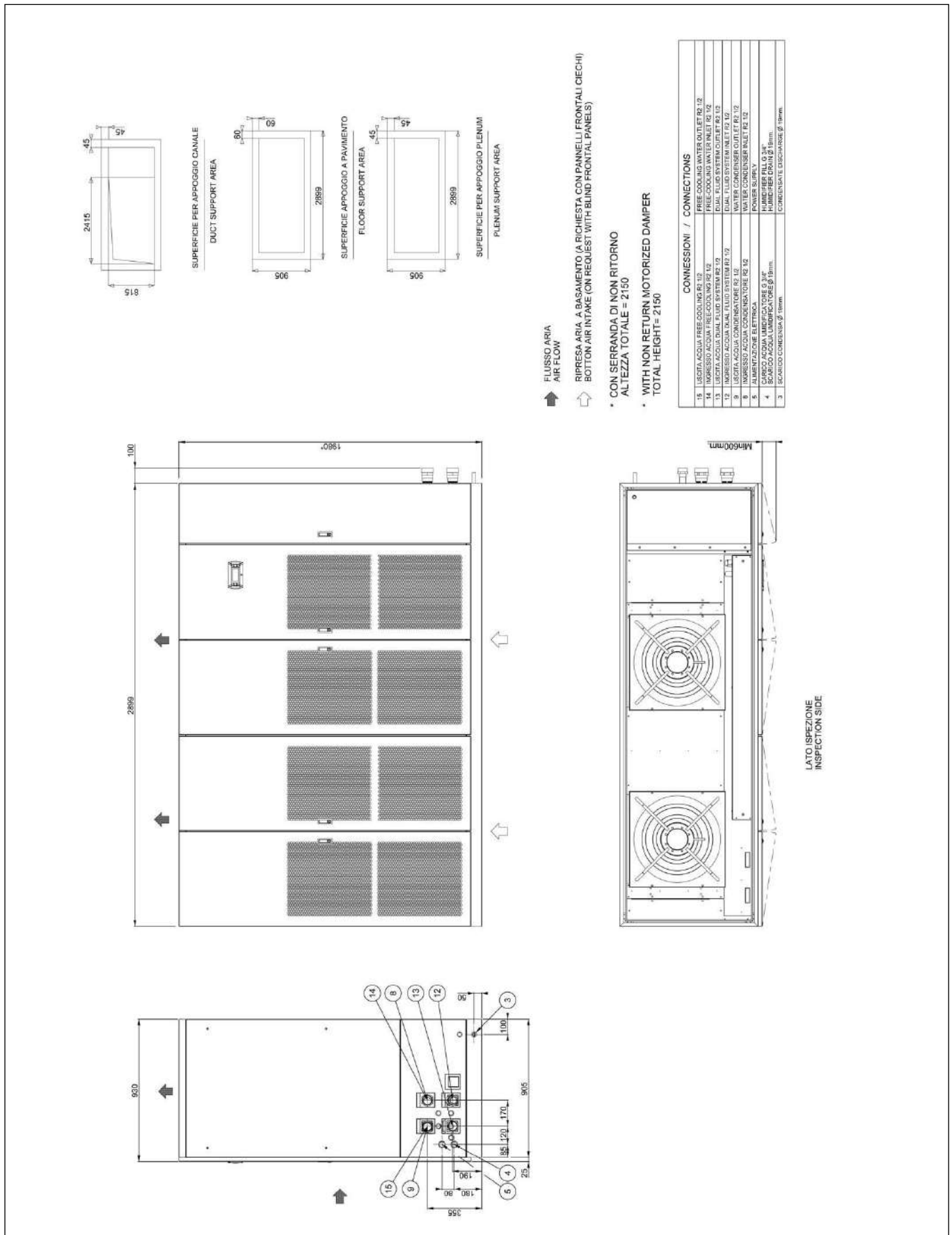



**HOLE IN THE RAISED FLOOR FOR DOWNFLOW VERSION**

**HOLE IN THE RAISED FLOOR WITHOUT FLOOR STAND**

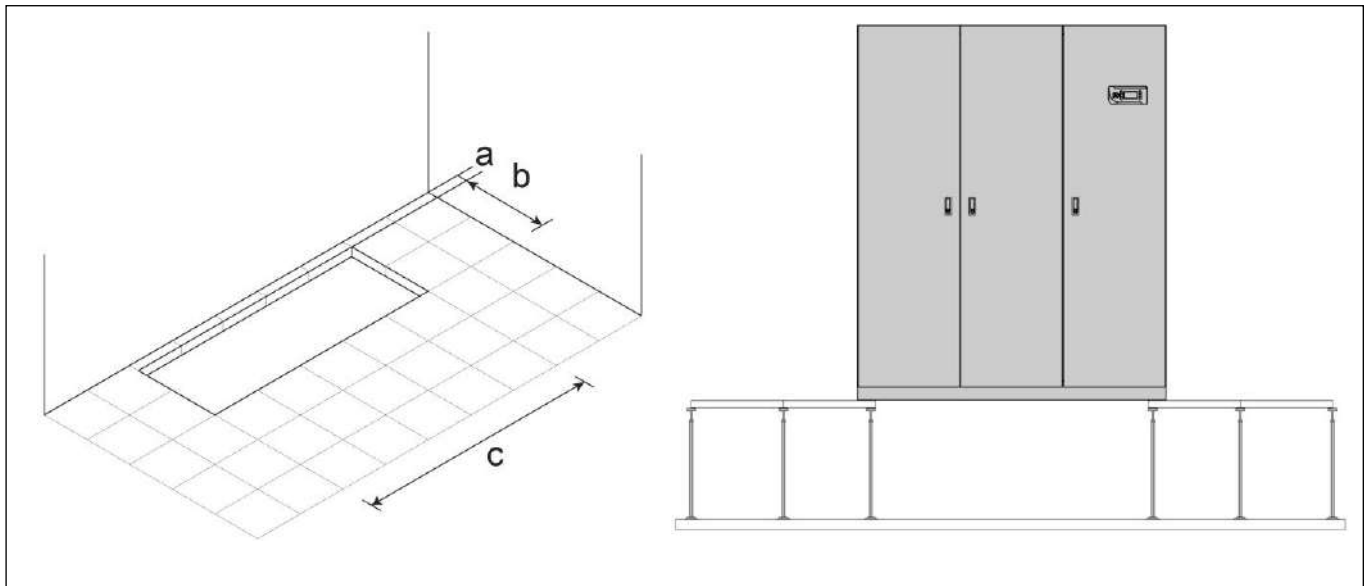

Foresee a hole in the floor with the following dimensions:

SIZE		E0	E1	E2	E3	E4L	E5L	E6L	E7L	E8L	E9L
a	mm	90	95	95	95	110	110	110	110	110	110
b	mm	340	560	560	660	785	785	785	785	785	785
c	mm	585	560	695	995	1510	1835	2080	2400	2780	3180

**HOLE IN THE RAISED FLOOR WITH FLOOR STAND (OPTION)**

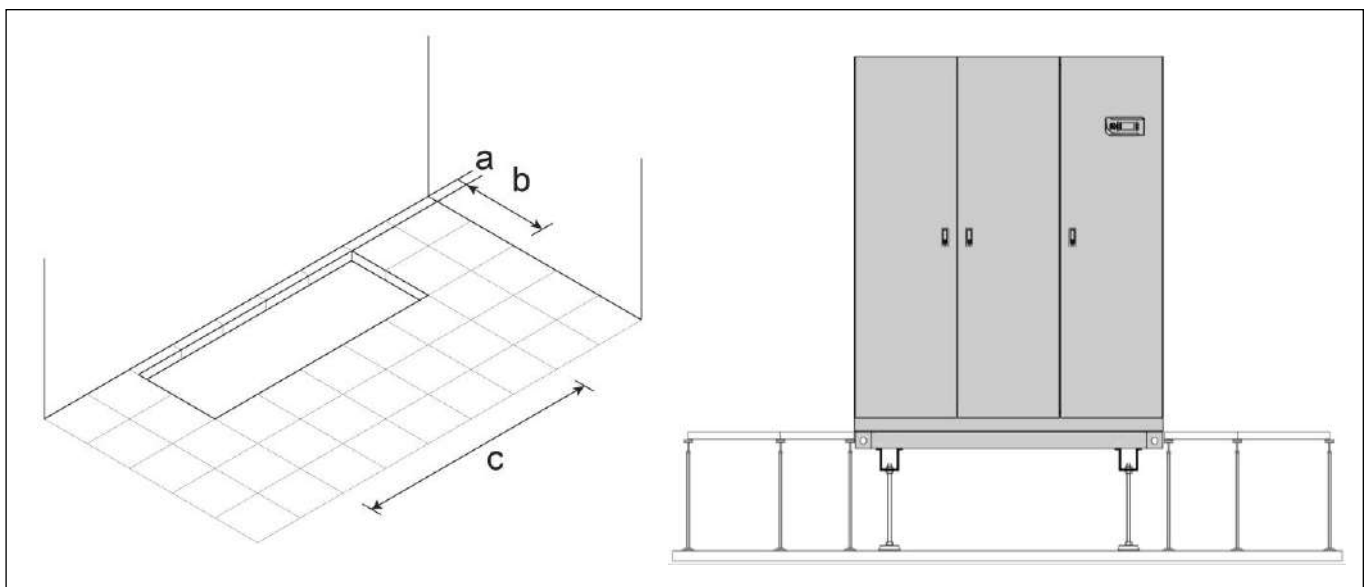

Foresee a hole in the floor with the following dimensions:

SIZE		E0	E1	E2	E3	E4L	E5L	E6L	E7L	E8L	E9L
a	mm	50	50	50	50	50	50	50	50	50	50
b	mm	440	670	670	770	925	925	925	925	925	925
c	mm	675	670	805	1105	1650	1975	2220	2520	2920	3320

EXAMPLE FOR MACHINES NOISE EMISSION CALCULATION

UNDER MACHINE WITH DUCT ON AIR INTAKE

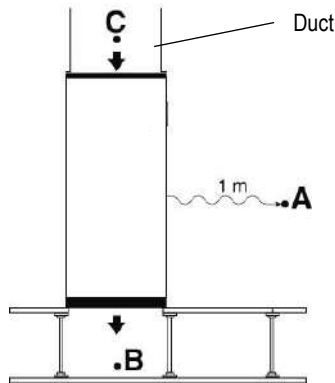

- Lp A = Front side Under catalogue value
- Lp B = Air delivery Under catalogue value
- Lp C = Air intake Under catalogue value
- The points B and C do not influence the point A

UNDER MACHINE WITH PLENUM ON AIR DELIVERY

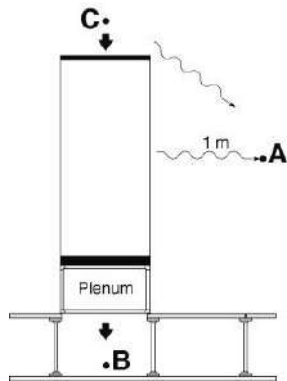

- Lp A = Front side Under catalogue value
- Lp B = Air delivery Under catalogue value – plenum noise reduction
- Lp C = Air intake Under catalogue value
- $Lp A+C = 10 \log_{10} \left( 10^{\frac{LpA}{10}} + 10^{\frac{LpC}{10}} \right)$
- The point B do not influence the point A

UNDER MACHINE WITH PLENUM ON AIR INTAKE

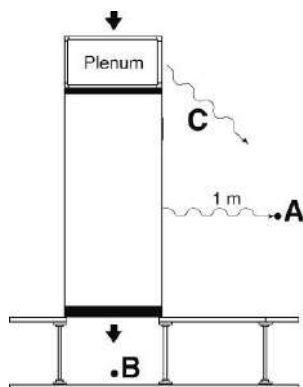

- Lp A = Front side Under catalogue value
- Lp B = Air delivery Under catalogue value
- Lp C = Air intake Under catalogue value – plenum noise reduction
- $Lp A+C = 10 \log_{10} \left( 10^{\frac{LpA}{10}} + 10^{\frac{LpC}{10}} \right)$
- The point B do not influence the point A

OVER MACHINE WITH DUCT

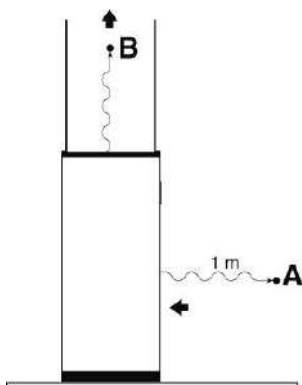

- Lp A = Air intake Over catalogue value
- Lp B = Air delivery Over catalogue value
- The point B do not influence the point A

EXAMPLE FOR MACHINES NOISE EMISSION CALCULATION

OVER MACHINE WITH PLENUM ON AIR DELIVERY

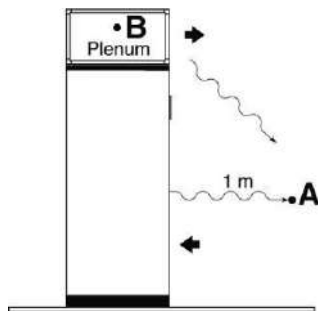

Lp A = Air intake Over catalogue value

Lp B = Air delivery Over catalogue value – plenum noise reduction

$$Lp A+B = 10 \log_{10} \left( 10^{\frac{LpA}{10}} + 10^{\frac{LpC}{10}} \right)$$

OVER MACHINE WITH DUCT AND PLENUM ON AIR DELIVERY

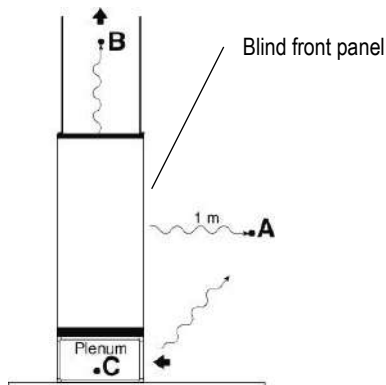

Lp A = Front side Over catalogue value

Lp B = Air delivery Over catalogue value

Lp C = Lp A + 6dB(A) – plenum noise reduction

$$Lp A+C = 10 \log_{10} \left( 10^{\frac{LpA}{10}} + 10^{\frac{LpC}{10}} \right)$$

The point B do not influence the point A+C

OVER MACHINE WITH DUCT AND PLENUM ON AIR DELIVERY

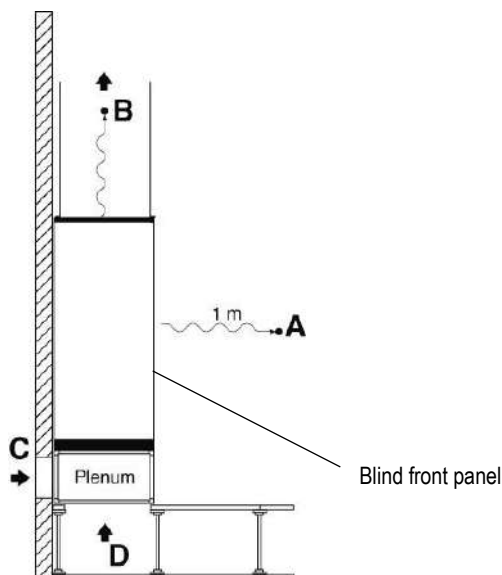

Lp A = Front side Over catalogue value

Lp B = Air delivery Over catalogue value

Lp C = Lp D = Lp A + 6 dB(A) – plenum noise reduction

The points B, C and D do not influence the point A

**IMPORTANT**

The declared noise levels are intended in free field conditions.

The noise pressure level of an installed unit is affected by the room acoustic characteristics.

Please consider an average noise increase of +4/+6 dB(A).

### VALVE PRESSURE DROP CALCULATION AS FUNCTION OF WATER FLOW RATE

Flow coefficient  $k_v$  defines the water flow (between 5°C and 40°C) expressed in m<sup>3</sup>/h that cross a valve with a pressure drop of 1bar (100kPa).

With this data is possible to calculate the localized pressure drop as function of the water flow rate.

$$\Delta P = (Q / k_v)^2$$

$\Delta P$  (bar) = localized pressure drop of valve;

$Q$  (m<sup>3</sup>/h) = water flow rate – it varies according to the desired operating condition;

$k_v$  (m<sup>3</sup>/h) = valve flow coefficient.

The formula allows to calculate the value of the localized pressure drop (in bar).

The pressure drops values showed on the documentation are supplied in kPa.

Is possible to change from one unit to another through the following conversion.

$$1 \text{ bar} = 100\text{kPa}$$

### CALCULATION EXAMPLE OF CONDENSING CONTROL VALVE PRESSURE DROP IN FUNCTION OF CONDENSER WATER FLOW RATE.

#### Model 092 P2 D E8L

Example at nominal conditions. Characteristics referred to entering air at 26°C-40%UR; water to the condenser 30-35°C

Condenser water flow rate: 19,5 m<sup>3</sup>/h

Condenser pressure drop 20 kPa

Valve flow coefficient  $k_v$ : 25 m<sup>3</sup>/h

Condensing control valve pressure drop:  $\Delta P = (Q / k_v)^2 = (19,5 / 25)^2 = 0,608 \text{ (bar)} * 100 \text{ (kPa / bar)} = 60,8 \text{ kPa}$

Pressure drop (condenser + valve) = 16 + 61 = 77 kPa

### AIR FILTERS REPLACEMENT

FOR UNDER VERSION MACHINES SIZE E4L – E5L – E6L – E7L – E8L – E9L

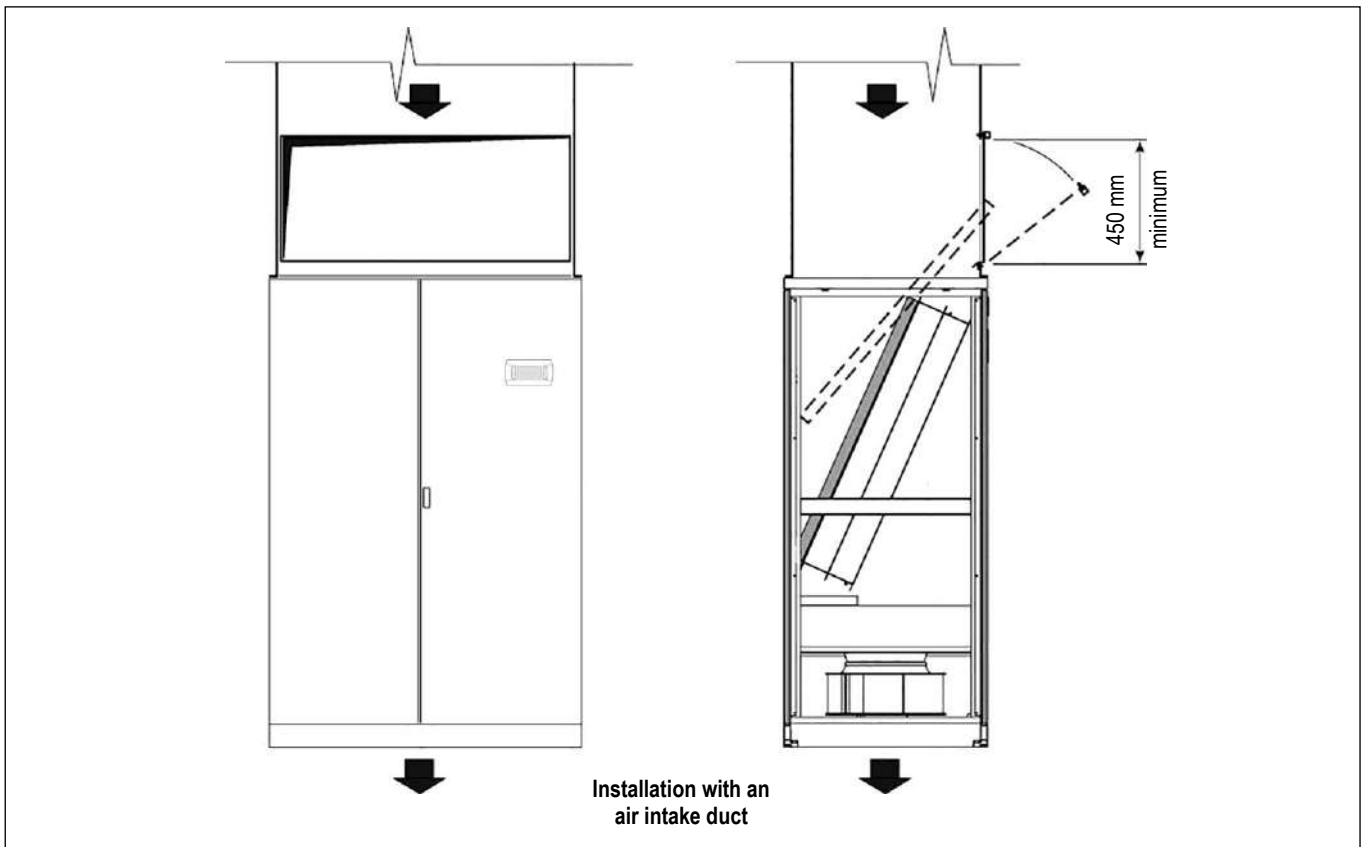
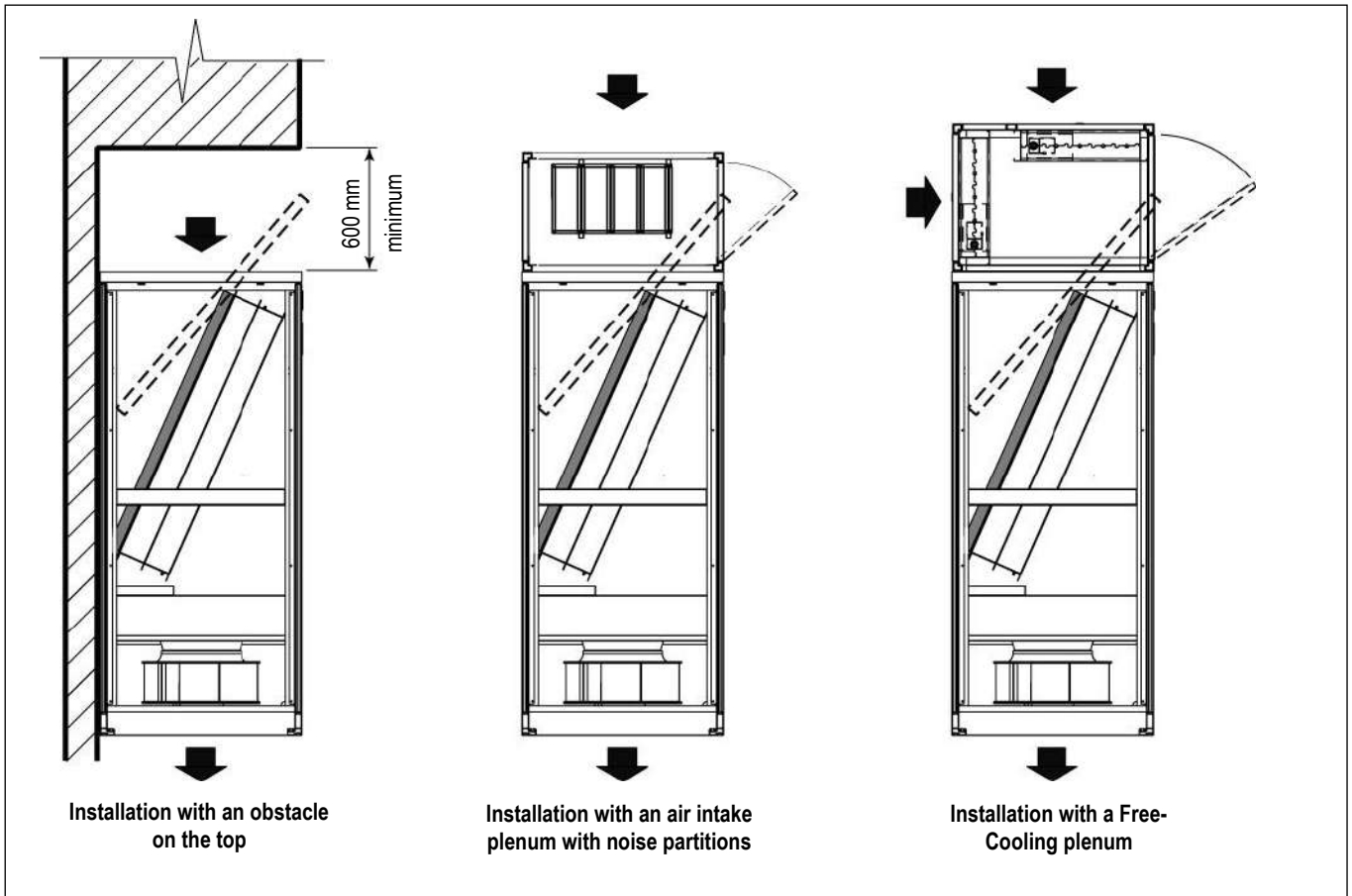

**SHIPMENT: PACKING DIMENSIONS**

Values referred to basic machine. The presence of some accessories increases the weight of machine.

The machines are shipped on pallet and covered with shrink wrap.  
On request packing on pallet covered with shrink wrap and wooden cage.

**STANDARD PACKING DIMENSIONS**

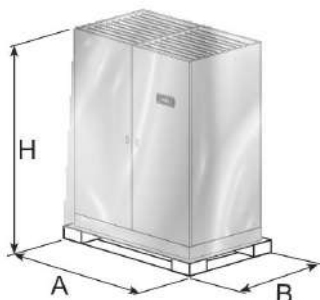

Size	A (mm)	B (mm)	H (mm)
E1	750	750	2080
E2	900	750	2080
E3	1200	910	2080
E4L	1750	1050	2130
E5L	2050	1050	2130
E6L	2280	1050	2130
E7L	2650	1050	2130
E8L	3000	1050	2130
E9L	3510	1050	2130

**OPTIONAL 9973: WOODEN CAGE PACKING DIMENSIONS**

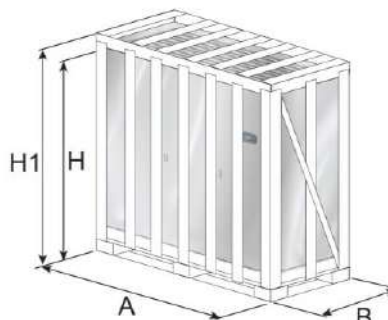

Size	A (mm)	B (mm)	H (mm)	H1 (*) (mm)
E1	790	790	2150	2350
E2	940	790	2150	2350
E3	1240	950	2150	2350
E4L	1790	1090	2200	2350
E5L	2090	1090	2200	2350
E6L	2320	1090	2200	2350
E7L	2690	1090	2200	2350
E8L	3040	1090	2200	2350
E9L	3550	1090	2200	2350

H1 (\*) = Packing height with optional A531 on/off damper

**SHIPMENT: SHIPPING WEIGHT**

**STANDARD PACKING**

Model	007 P1 S	009 P1 S	011 P1 S	014 P1 S	016 P1 S	020 P1 S	022 P1 S	026 P1 S	032 P1 S	037 P1 S	041 P1 S	045 P1 S
Size	E1	E1	E1	E2	E2	E3	E3	E3	E4L	E4L	E4L	E4L
Weight UNDER kg	259	261	264	300,2	305,2	361	366	366	546	546	551	551
Weight OVER kg	249	251	254	290,2	295,2	341	346	346	536	536	541	541

Model	039 P2 D	048 P2 D	055 P2 D	062 P2 D	075 P2 D	082 P2 D	092 P2 D	102 P2 D	117 P4 D	146 P4 D
Size	E5L	E5L	E6L	E6L	E7L	E7L	E8L	E8L	E9L	E9L
Weight UNDER kg	686,5	686,5	756	756	828,5	828,5	1051,5	1051,5	1211	1261
Weight OVER kg	676,5	676,5	736	736	778,5	778,5	991,5	991,5	--	--

## OPTIONAL 9973: WOODEN CAGE PACKING

Model		007 P1	009 P1	011 P1	014 P1	016 P1	020 P1	022 P1	026 P1	032 P1	037 P1	041 P1	045 P1
		S	S	S	S	S	S	S	S	S	S	S	S
Size		E1	E1	E1	E2	E2	E3	E3	E3	E4L	E4L	E4L	E4L
Weight UNDER	kg	286	288	291	328,2	333,2	393	398	398	582	582	587	587
Weight UNDER (1)	kg	308	310	313	353,2	358,2	426	431	431	632	632	637	637
Weight OVER	kg	276	278	281	318,2	323,2	373	378	378	572	572	577	577
Weight OVER (1)	kg	298	300	303	343,2	348,2	406	411	411	622	622	627	627

Model		039 P2	048 P2	055 P2	062 P2	075 P2	082 P2	092 P2	102 P2	117 P4	146 P4
		D	D	D	D	D	D	D	D	D	D
Size		E5L	E5L	E6L	E6L	E7L	E7L	E8L	E8L	E9L	E9L
Weight UNDER	kg	732,5	732,5	808	808	878,5	878,5	1109,5	1109,5	1270	1320
Weight UNDER (1)	kg	792,5	792,5	878	878	956,5	956,5	1197,5	1197,5	1373	1423
Weight OVER	kg	722,5	722,5	788	788	828,5	828,5	1049,5	1049,5	--	--
Weight OVER (1)	kg	782,5	782,5	858	858	906,5	906,5	1137,5	1137,5	--	--

(1) Machine with optional A531 on/off damper

## SHIPMENT: OPTIONALS PACKING DIMENSIONS AND SHIPPING WEIGHT

- P011 - EMPTY PLENUM
- P012 - EMPTY PLENUM CL.A1
- P031 - EMPTY INTAKE PLENUM
- P032 - EMPTY INTAKE PLENUM CL.A1
- P013 - PLENUM + 3 GRILLES
- P014 - PLENUM + 3 GRILLES CL.A1
- P015 - SILENCED PLENUM
- P016 - SILENCED PLENUM + 1 GRILLE
- P017 - PLENUM + FILTER EPM2.5 50%
- P018 - PLENUM + FILTER EPM1 50%
- P019 - PLENUM + FILTER EPM1 85%

The plenums are shipped on pallet and covered with shrink wrap.

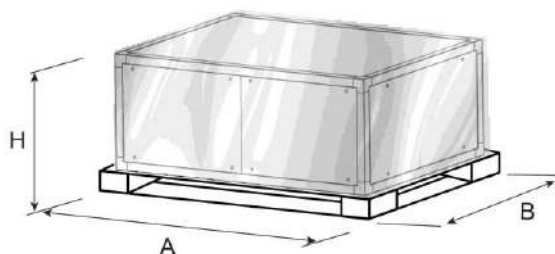

Size		E1	E2	E3	E4L	E5L	E6L	E7L	E8L	E9L
<b>DIMENSIONS</b>										
A	mm	750	900	1200	1750	2050	2280	2650	3000	3510
B	mm	750	750	910	1050	1050	1050	1050	1050	1050
H	mm	630	630	630	630	630	630	630	630	630
<b>SHIPPING WEIGHT</b>										
P011 - Empty plenum "O" / "U"	kg	31	34	41	69	81	90	105	122	138
P012 - Empty plenum CL.A1 "O" / "U"	kg	36	39	47	79	92	101	119	137	158
P031 - Empty intake plenum "O" / "U"	kg	31	34	41	69	81	90	105	122	138
P032 - Empty intake plenum CL. A1 "O" / "U"	kg	36	39	47	79	92	101	119	137	158
P013 - Plenum + 3 grilles "O" / "U"	kg	32	35	47	79	99	110	135	146	178
P014 - Plenum + 3 grilles CL. A1 "O" / "U"	kg	36	40	54	90	110	125	151	170	192
P015 - Silenced plenum "O" / "U"	kg	36	39	47	81	102	116	130	152	170
P016 - Silenced plenum + 1 grille "O" / "U"	kg	41	44	54	101	115	130	155	182	200
P017 - P018 - P019 - Plenum + filter "O" / "U"	kg	37	39	47	84	106	120	135	152	170

"O" Over / "U" Under

**P034: INTAKE FREE-COOLING PLENUM**

The plenums are shipped on pallet and covered with shrink wrap.

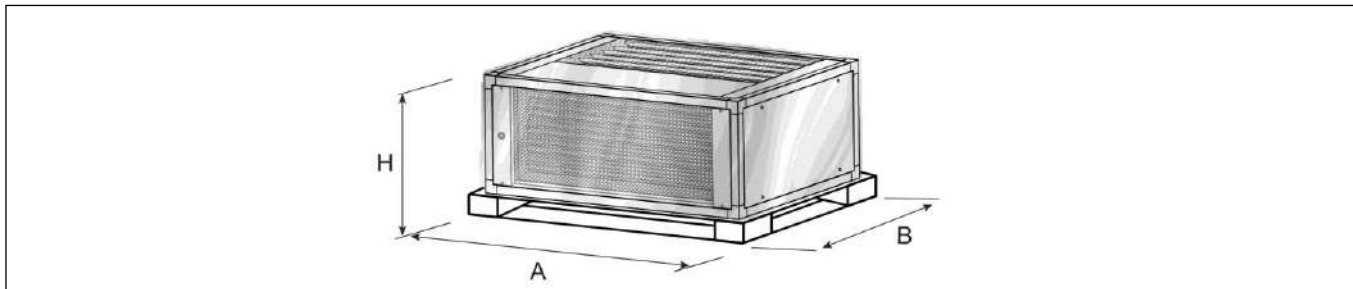

Size		E1	E2	E3	E4L	E5L	E6L	E7L	E8L	E9L
<b>DIMENSIONS</b>										
A	mm	750	900	1200	1750	2050	2280	2650	3000	3510
B	mm	750	750	910	1050	1050	1050	1050	1050	1050
H	mm	630	630	630	750	750	750	750	750	750
<b>SHIPPING WEIGHT</b>										
P034 - Intake free-cooling plenum "U"	kg	35	39	52	90	115	132	155	182	205
P034 - Intake free-cooling plenum "O"	kg	35	39	52	90	115	132	155	182	205

"O" Over / "U" Under

**P041 / P042 / P043: SUPPORT FRAME**

The support frames are shipped on pallet and covered with shrink wrap.

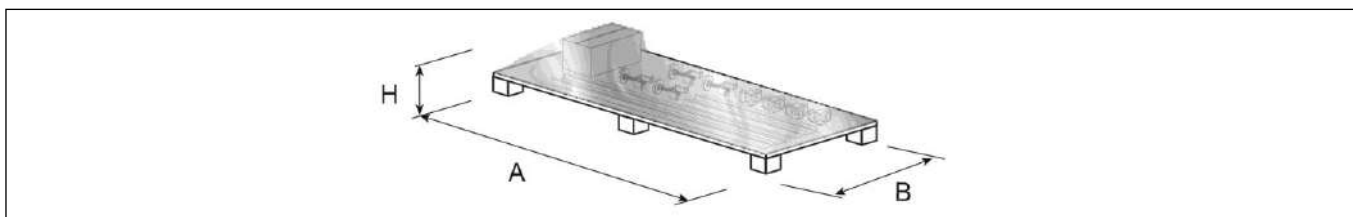

Size		E1	E2	E3	E4L	E5L	E6L	E7L	E8L	E9L
<b>DIMENSIONS</b>										
A	mm	1200	1200	1200	1750	2050	2280	2650	3000	3510
B	mm	900	900	900	900	900	900	900	900	900
H	mm	500	500	500	500	500	500	500	500	500
<b>SHIPPING WEIGHT</b>										
	kg	26	27	29	40	45	47	49	53	58

**P183 / P184: KIT NETWORK ANALYZER / KIT NETWORK ANALYZER+OPTIONAL**  
**P113 / P114: DUAL POWER SUPPLY KIT / DUAL POWER SUPPLY KIT+OPTIONAL**

The optionals are shipped in a cardboard box.

**P183 / P184 - KIT NETWORK ANALYZER / KIT NETWORK ANALYZER+OPTIONAL**

Size		E1	E2	E3	E4L	E5L	E6L	E7L	E8L	E9L
<b>DIMENSIONS</b>										
A	mm	410	410	410	--	--	--	--	--	--
B	mm	410	410	410	--	--	--	--	--	--
H	mm	210	210	210	--	--	--	--	--	--
<b>SHIPPING WEIGHT</b>										
	kg	5	5	5	--	--	--	--	--	--

**P113 / P114 - DUAL POWER SUPPLY KIT / DUAL POWER SUPPLY KIT+OPTIONAL**

Size		E1	E2	E3	E4L	E5L	E6L	E7L	E8L	E9L
<b>DIMENSIONS</b>										
A	mm	400	400	400	400	--	--	--	--	--
B	mm	400	400	400	400	--	--	--	--	--
H	mm	210	210	210	210	--	--	--	--	--
<b>SHIPPING WEIGHT</b>										
	kg	12	12	12	12	--	--	--	--	--

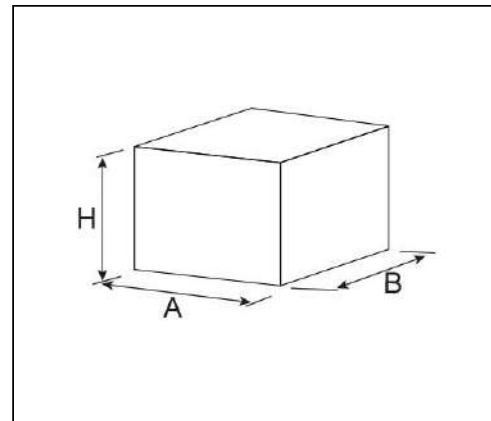











for a greener tomorrow

Eco Changes is the Mitsubishi Electric Group's environmental statement, and expresses the Group's stance on environmental management. Through a wide range of businesses, we are helping contribute to the realization of a sustainable society.



## MITSUBISHI ELECTRIC HYDRONICS & IT COOLING SYSTEMS S.p.A.

Via Caduti di Cefalonia, 1 - 36061 Bassano del Grappa (VI) Italy  
Ph. (+39) 0424 509 500 • Fax (+39) 0424 509 509  
[www.melcohit.com](http://www.melcohit.com)

